

NOTE

In order to accommodate clearer type, larger charts and graphs, and more detailed illustrations, this edition of the O-360, HO-360, IO-360, AIO-360, HIO-360 and TIO-360 Operator's Manual, Lycoming Part Number 60297-12, is presented in an 8-1/2 x 11 inch format. This edition is a complete manual, current as of the date of issue. The manual incorporates all previously issued revisions.

This manual will be kept current by revisions available from Lycoming distributors or from the factory. All revisions will be accompanied by an Operator's Manual Revision page which will identify the revision level, the date of the revision, and the pages revised, added or deleted. All revisions will be supplied in the 8-1/2 x 11 inch format.

Operator's Manual

Lycoming

O-360, HO-360,

IO-360, AIO-360,

HIO-360 & TIO-360 Series

Approved by FAA

8th Edition

Part No. 60297-12

LYCOMING

A Textron Company

652 Oliver Street
Williamsport, PA. 17701 U.S.A.
570/323-6181

October 2005



A Textron Company

OPERATOR'S MANUAL REVISION

REVISION NO.	PUBLICATION	PUBLICATION NO.	PUBLICATION DATE
60297-12-4	O-360, HO-360, IO-360, AIO-360, HIO-360 & TIO-360 Series	60297-12	October 2005
The page(s) in this revision replace, add to, or delete current pages in the operator's manual.			
PREVIOUS REVISION		CURRENT REVISION	
June 2007 Web Page; 3-38 September 2007 3-8, 3-9, 3-11 December 2007 3-4, 3-5		March 2009 1-5; Section 2 Index, 2-3, 2-8, 2-11; 3-5, 3-21, 3-41	

©2009 by Lycoming "All Rights Reserved"

Lycoming Engines, a division of AVCO Corporation, a wholly owned subsidiary of Textron Inc.



A Textron Company

OPERATOR'S MANUAL REVISION

REVISION NO.	PUBLICATION	PUBLICATION NO.	PUBLICATION DATE
60297-12-3	O-360, HO-360, IO-360, AIO-360, HIO-360 & TIO-360 Series	60297-12	October 2005
The page(s) in this revision replace, add to, or delete current pages in the operator's manual.			
PREVIOUS REVISION		CURRENT REVISION	
June 2007 Web Page; 3-38 September 2007 3-8, 3-9, 3-11		December 2007 3-4, 3-5	



A Textron Company

OPERATOR'S MANUAL REVISION

REVISION NO.	PUBLICATION	PUBLICATION NO.	PUBLICATION DATE
60297-12-2	O-360, HO-360, IO-360, AIO-360, HIO-360 & TIO-360 Series	60297-12	October 2005
The page(s) in this revision replace, add to, or delete current pages in the operator's manual.			
PREVIOUS REVISION		CURRENT REVISION	
June 2007 Web Page; 3-38		September 2007 3-8, 3-9, 3-11	



A Textron Company

OPERATOR'S MANUAL REVISION

REVISION NO.	PUBLICATION	PUBLICATION NO.	PUBLICATION DATE
60297-12-1	O-360, HO-360, IO-360, AIO-360, HIO-360 & TIO-360 Series	60297-12	October 2005
The page(s) in this revision replace, add to, or delete current pages in the operator's manual.			
PREVIOUS REVISION		CURRENT REVISION	
None		June 2007 Web Page; 3-38	

O, HO, IO, AIO, HIO, TIO-360 Series Operator's Manual

Lycoming Part Number: 60297-12

©2005 by Lycoming. All rights reserved.

Lycoming and "Powered by Lycoming" are trademarks or registered trademarks of Lycoming.

All brand and product names referenced in this publication are trademarks or registered trademarks of their respective companies.

For additional information:

Mailing address:

Lycoming Engines
652 Oliver Street
Williamsport, PA 17701 U.S.A.

Phone:

Factory: 570-323-6181
Sales Department: 570-327-7268
Fax: 570-327-7101

Lycoming's regular business hours are Monday through Friday from 8:00 AM through 5:00 PM Eastern Time (-5 GMT)

Visit us on the World Wide Web at:

| <http://www.lycoming.com>

Revised June 2007

LYCOMING OPERATOR'S MANUAL

ATTENTION

OWNERS, OPERATORS, AND MAINTENANCE PERSONNEL

This operator's manual contains a description of the engine, its specifications, and detailed information on how to operate and maintain it. Such maintenance procedures that may be required in conjunction with periodic inspections are also included. This manual is intended for use by owners, pilots and maintenance personnel responsible for care of Lycoming powered aircraft. Modifications and repair procedures are contained in Lycoming overhaul manuals; maintenance personnel should refer to these for such procedures.

SAFETY WARNING

NEGLECTING TO FOLLOW THE OPERATING INSTRUCTIONS AND TO CARRY OUT PERIODIC MAINTENANCE PROCEDURES CAN RESULT IN POOR ENGINE PERFORMANCE AND POWER LOSS. ALSO, IF POWER AND SPEED LIMITATIONS SPECIFIED IN THIS MANUAL ARE EXCEEDED, FOR ANY REASON; DAMAGE TO THE ENGINE AND PERSONAL INJURY CAN HAPPEN. CONSULT YOUR LOCAL FAA APPROVED MAINTENANCE FACILITY.

SERVICE BULLETINS, INSTRUCTIONS, AND LETTERS

Although the information contained in this manual is up-to-date at time of publication, users are urged to keep abreast of later information through Lycoming Service Bulletins, Instructions and Service Letters which are available from all Lycoming distributors or from the factory by subscription. Consult the latest revision of Service Letter No. L114 for subscription information.

SPECIAL NOTE

The illustrations, pictures and drawings shown in this publication are typical of the subject matter they portray; in no instance are they to be interpreted as examples of any specific engine, equipment or part thereof.

LYCOMING OPERATOR'S MANUAL

IMPORTANT SAFETY NOTICE

Proper service and repair is essential to increase the safe, reliable operation of all aircraft engines. The service procedures recommended by Lycoming are effective methods for performing service operations. Some of these operations require the use of tools specially designed for the task. These special tools must be used when and as recommended.

It is important to note that most Lycoming publications contain various Warnings and Cautions which must be carefully read in order to minimize the risk of personal injury or the use of improper service methods that may damage the engine or render it unsafe.

It is also important to understand that these Warnings and Cautions are not all inclusive. Lycoming could not possibly know, evaluate or advise the service trade of all conceivable ways in which service might be done or of the possible hazardous consequences that may be involved. Accordingly, anyone who uses a service procedure must first satisfy themselves thoroughly that neither their safety nor aircraft safety will be jeopardized by the service procedure they select.



A Textron Company

WARRANTY

NEW AND REBUILT ENGINES

(1) **WARRANTY AND REMEDY:** Lycoming Engines, a division of Avco Corporation (hereinafter “Lycoming”) warrants each new Lycoming reciprocating engine to be free from defect in material or workmanship under normal use and service. Lycoming’s sole obligation under this warranty is limited to replacement or repair of parts which are determined by Lycoming to have been defective within a period of twenty-four (24) months after new aircraft delivery to the original retail purchaser or first user, or twenty-four (24) months from the date of first operation. The warranty period of twenty-four (24) months commences on the earlier of the date of first operation after new aircraft delivery to the original retail purchaser or first user, or twenty-four (24) months from the date of shipment from Lycoming. Lycoming will, in connection with the foregoing warranty, cover reimbursement of reasonable freight charges with respect to any such warranty replacement or repair.

(2) Within the warranty period, Lycoming will reimburse the Purchaser for labor charges associated with warranty related issues. Lycoming will only reimburse the cost of such labor charges in connection with repair or replacement of parts as provided in Lycoming’s then current Removal and Installation Labor and Allowance Guidebook. Spare parts installed as warranty replacement on engines which are covered by this New Engine Warranty will be warranted for the balance of the original warranty period or for the spare part warranty, whichever is the greater. Replacement of parts may be with either new or reconditioned parts, at Lycoming’s election. A claim for warranty on any part claimed to be defective must be reported in writing to Lycoming’s Warranty Administration within 60 days of being found to require repair or replacement by the purchaser or service facility. Warranty adjustment is contingent upon the Purchaser complying with the Lycoming’s Warranty Administration disposition instructions for defective parts. Failure to comply with all of the terms of this paragraph may, at Lycoming’s sole option, void this warranty.

(3) **THIS WARRANTY IS GIVEN AND ACCEPTED IN PLACE OF (i) ALL OTHER WARRANTIES OR CONDITIONS, EXPRESS OR IMPLIED, INCLUDING BUT NOT LIMITED TO THE IMPLIED WARRANTIES OR CONDITION OF MERCHANTABILITY AND FITNESS FOR A PARTICULAR PURPOSE AND (ii) ANY OBLIGATION, LIABILITY, RIGHT, CLAIM OR REMEDY IN CONTRACT OR IN TORT (DELICT), INCLUDING PRODUCT LIABILITIES BASED UPON STRICT LIABILITY, NEGLIGENCE, OR IMPLIED WARRANTY IN LAW AND PURCHASER HEREBY WAIVES SUCH RIGHTS AND CLAIMS.**

(4) **THIS WARRANTY IS THE ONLY WARRANTY MADE BY LYCOMING. THE PURCHASER’S SOLE REMEDY FOR A BREACH OF THIS WARRANTY OR ANY DEFECT IN A PART IS THE REPAIR OR REPLACEMENT OF ENGINE PARTS AND REIMBURSEMENT OF REASONABLE FREIGHT CHARGES AS PROVIDED HEREIN. LYCOMING EXCLUDES LIABILITY, WHETHER AS A RESULT OF A BREACH OF CONSEQUENTIAL DAMAGES, INCLUDING, BUT NOT LIMITED TO, DAMAGE TO THE ENGINE OR OTHER PROPERTY (INCLUDING THE AIRCRAFT IN WHICH THE ENGINE IS INSTALLED), COSTS AND EXPENSES RESULTING FROM REQUIRED CHANGES OR MODIFICATIONS TO ENGINE COMPONENTS AND ASSEMBLIES, CHANGES IN RETIREMENT LIVES AND OVERHAUL PERIODS, LOCAL CUSTOMS FEES AND TAXES, AND COSTS OR EXPENSES FOR COMMERCIAL LOSSES OR LOST PROFITS DUE TO LOSS OF USE OR GROUNDING OF THE AIRCRAFT IN WHICH THE ENGINE IS INSTALLED OR OTHERWISE. LYCOMING’S TOTAL LIABILITY FOR ANY AND ALL CLAIMS RELATED TO ANY ENGINE SHALL IN NO CASE EXCEED THE ORIGINAL SALES PRICE OF THE ENGINE. SELLER MAKES NO WARRANTY AND DISCLAIMS ALL LIABILITY WITH RESPECT TO COMPONENTS OR PARTS DAMAGED BY, OR WORN DUE TO, CORROSION.**

LYCOMING

A Textron Company

(5) This warranty shall not apply to any engine or part thereof which has been repaired or altered outside Lycoming's factory in any way so as, in Lycoming's sole judgment, to affect its durability, safety or reliability, or which has been subject to misuse, negligence or accident. Repairs and alterations which use or incorporate parts and components other than genuine Lycoming parts or parts approved by Lycoming for direct acquisition from sources other than Lycoming itself are not warranted by Lycoming, and this warranty shall be void to the extent that such repairs and alterations, in Lycoming's sole judgment, affect the durability, safety or reliability of the engine or any part thereof, or damage genuine Lycoming or Lycoming-approved parts. No person, corporation or organization, including Distributors of Lycoming engines, is authorized by Lycoming to assume for it any other liability in connection with the sale of its engines or parts, nor to make any warranties beyond the foregoing warranty nor to change any of the terms hereof. NO STATEMENT, WHETHER WRITTEN OR ORAL, MADE BY ANY PERSON, CORPORATION OR ORGANIZATION, INCLUDING DISTRIBUTORS OF LYCOMING ENGINES MAY BE TAKEN AS A WARRANTY NOR WILL IT BIND LYCOMING. NO AGREEMENT VARYING THE TERMS OF THIS WARRANTY OR LYCOMING'S OBLIGATIONS UNDER IT IS BINDING UPON LYCOMING UNLESS IN WRITING AND SIGNED BY A DULY AUTHORIZED REPRESENTATIVE OF LYCOMING.

(6) All legal actions based upon claims or disputes pertaining to or involving this warranty including, but not limited to, Lycoming's denial of any claim or portion thereof under this warranty, must be filed in the courts of general jurisdiction of Lycoming County, Commonwealth of Pennsylvania or in the United States District Court for the Middle District of Pennsylvania located in Williamsport, Pennsylvania. In the event that Purchaser files such an action in either of the court systems identified above, and a final judgment in Lycoming's favor is rendered by such court, then Purchaser shall indemnify Lycoming for all costs, expenses and attorneys' fee incurred by Lycoming in defense of such claims. In the event Purchaser files such a legal action in a court other than those specified, and Lycoming successfully obtains dismissal of that action or transfer thereof to the above described court systems, then Purchaser shall indemnify Lycoming for all costs, expenses and attorneys' fees incurred by Lycoming in obtaining such dismissal or transfer.

(7) Any invalidity of a provision of this Warranty shall not affect any other provision, and in the event of a judicial finding of such invalidity, this Agreement shall remain in force in all other respects.

Effective September 2006 Revision "M"

Lycoming Engines
652 Oliver Street
Williamsport, Pennsylvania
17701
(570) 323-6181
www.lycoming.textron.com



LYCOMING OPERATOR'S MANUAL

TABLE OF CONTENTS

		Page
SECTION 1	DESCRIPTION	1-1
SECTION 2	SPECIFICATIONS	2-1
SECTION 3	OPERATING INSTRUCTIONS	3-1
SECTION 4	PERIODIC INSPECTIONS	4-1
SECTION 5	MAINTENANCE PROCEDURES	5-1
SECTION 6	TROUBLE-SHOOTING	6-1
SECTION 7	INSTALLATION AND STORAGE	7-1
SECTION 8	TABLES	8-1

This Page Intentionally Left Blank

LYCOMING OPERATOR'S MANUAL

**SECTION 1
DESCRIPTION**

	Page
General.....	1-1
Cylinders.....	1-1
Valve Operating Mechanism	1-1
Crankcase	1-1
Crankshaft.....	1-1
Connecting Rods	1-2
Pistons	1-2
Accessory Housing	1-2
Oil Sump	1-2
Cooling System.....	1-2
Induction System.....	1-2
Lubrication System.....	1-3
Priming System	1-3
Ignition System.....	1-3
Counterweight System.....	1-3
Model Application Table.....	1-3

This Page Intentionally Left Blank

SECTION 1

DESCRIPTION

The O, HO, IO, AIO, HIO, LIO and TIO-360 series are four cylinder, direct drive, horizontally opposed, air-cooled engines.

In referring to the location of the various engine components, the parts are described as installed in the airframe. Thus, the power take-off end is the front and the accessory drive end the rear. The sump section is the bottom and the opposite side of the engine where the shroud tubes are located the top. Reference to the left and right side is made with the observer facing the rear of the engine. The cylinders are numbered from front to rear, odd numbers on the right. The direction of rotation of the crankshaft, viewed from the rear, is clockwise. Rotation for accessory drives is determined with the observer facing the drive pad.

NOTE

The letter "L" in the model prefix denotes the reverse rotation of the basic model. Example: model IO-360-C has clockwise rotation of the crankshaft. Therefore, LIO-360-C has counterclockwise rotation of the crankshaft. Likewise, the rotation of the accessory drives of the LIO-360-C is opposite those of the basic model as listed in Section 2 of this manual.

The letter "D" used as the 4th or 5th character in the model suffix denotes that the particular model employs dual magnetos housed in a single housing. Example: All information pertinent to the O-360-A1F6 will apply to the O-360-A1F6D.

Operational aspects of engines are the same and performance curves and specifications for the basic model will apply.

Cylinders – The cylinders are of conventional air-cooled construction with the two major parts, head and barrel, screwed and shrunk together. The heads are made from an aluminum alloy casting with a fully machined combustion chamber. Rocker shaft bearing supports are cast integral with the head along with housings to form the rocker boxes. The cylinder barrels have deep integral cooling fins and the inside of the barrels are ground and honed to a specified finish.

Valve Operating Mechanism – A conventional type camshaft is located above and parallel to the crankshaft. The camshaft actuates hydraulic tappets, which operate the valves through push rods and valve rockers. The valve rockers are supported on full floating steel shafts. The valve springs bear against hardened steel seats and are retained on the valve stems by means of split keys.

Crankcase – The crankcase assembly consists of two reinforced aluminum alloy castings, fastened together by means of studs, bolts and nuts. The mating surfaces of the two castings are joined without the use of a gasket, and the main bearing bores are machined for use of precision type main bearing inserts.

Crankshaft – The crankshaft is made from a chrome nickel molybdenum steel forging. All bearing journal surfaces are nitrided.

SECTION 1 DESCRIPTION

LYCOMING OPERATOR'S MANUAL O-360 AND ASSOCIATED MODELS

Connecting Rods – The connecting rods are made in the form of “H” sections from alloy steel forgings. They have replaceable bearing inserts in the crankshaft ends and bronze bushings in the piston ends. Two bolts and nuts through each cap retain the bearing caps on the crankshaft ends.

Pistons – The pistons are machined from an aluminum alloy. The piston pin is of a full floating type with a plug located in each end of the pin. Depending on the cylinder assembly, pistons may be machined for either three or four rings and may employ either half wedge or full wedge rings. Consult the latest revision of Service Instruction No. 1037 for proper piston and ring combinations.

Accessory Housing – The accessory housing is made from an aluminum casting and is fastened to the rear of the crankcase and the top rear of the sump. It forms a housing for the oil pump and the various accessory drives.

Oil Sump (Except AIO Series) – The sump incorporates an oil drain plug, oil suction screen, mounting pad for carburetor or fuel injector, the intake riser and intake pipe connections.

Crankcase Covers (AIO Series) – Crankcase covers are employed on the top and bottom of the engine. These covers incorporate oil suction screens, oil scavenge line connections. The top cover incorporates a connection for a breather line and the lower cover a connection for an oil suction line.

Cooling System – These engines are designed to be cooled by air pressure. Baffles are provided to build up a pressure and force the air through the cylinder fins. The air is then exhausted to the atmosphere through gills or augmentor tubes usually located at the rear of the cowling.

Induction System – Lycoming O-360 and HO-360 series engines are equipped with either a float type or pressure type carburetor. See Table 1 for model application. Particularly good distribution of the fuel-air mixture to each cylinder is obtained through the center zone induction system, which is integral with the oil sump and is submerged in oil, insuring a more uniform vaporization of fuel and aiding in cooling the oil in the sump. From the riser the fuel-air mixture is distributed to each cylinder by individual intake pipes.

Lycoming IO-360, AIO-360, HIO-360 and TIO-360 series engines are equipped with a Bendix type RSA fuel injector, with the exception of model IO-360-B1A that is equipped with a Simmonds type 530 fuel injector. (See Table 1 of model application.) The fuel injection system schedules fuel flow in proportion to air flow and fuel vaporization takes place at the intake ports. A turbocharger is mounted as an integral part of the TIO-360 series engines. Automatic waste gate control of the turbocharger provides constant air density to the fuel injector inlet from sea level to critical altitude.

A brief description of the carburetors and fuel injectors follows:

The Marvel-Schebler MA-4-5 and HA-6 carburetors are of the single barrel float type equipped with a manual mixture control and an idle cut-off.

The Marvel-Schebler MA-4-5AA carburetor is of the single barrel float type with automatic pressure altitude mixture control. This carburetor is equipped with idle cut-off but does not have a manual mixture control.

The Bendix-Stromberg PSH-5BD is a pressure operated, single barrel horizontal carburetor, incorporating an airflow operated power enrichment valve and an automatic mixture control unit. It is equipped with an idle cut-off and a manual mixture control. The AMC unit works independently of, and in parallel with, the manual mixture control.

**LYCOMING OPERATOR'S MANUAL
O-360 AND ASSOCIATED MODELS**

**SECTION 1
DESCRIPTION**

The Bendix RSA type fuel injection system is based on the principle of measuring air flow and using the air flow signal in a stem type regulator to convert the air force into a fuel force. This fuel force (fuel pressure differential) when applied across the fuel metering section (jetting system) makes fuel flow proportional to airflow.

The Simmonds type 530 is a continuous flow fuel injection system. This continuous flow system has three separate components:

1. A fuel pump assembly.
2. A throttle body assembly.
3. Four fuel flow nozzles.

This system is throttle actuated. Fuel is injected into the engine intake valve ports by the nozzles. The system continuously delivers metered fuel to each intake valve port in response to throttle position, engine speed and mixture control position. Complete flexibility of operation is provided by the manual mixture control, which permits the adjustment of the amount of injected fuel to suit all operating conditions. Moving the mixture control to "Idle Cut-Off" results in a complete cut-off of fuel to the engine.

Lubrication System – (All models except AIO-360 series). An impeller type pump contained within the accessory housing actuates the full pressure wet sump lubrication system.

AIO-360 Series – The AIO-360 series is designed for aerobatic flying and is of the dry sump type. A double scavenge pump is installed on the accessory housing.

Priming System – Provision for a primer system is provided on all engines employing a carburetor. Fuel injected engines do not require a priming system.

Ignition System – Dual ignition is furnished by two Bendix magnetos. Consult Table 1 for model application.

Counterweight System – Models designated by the numeral 6 in the suffix of the model number (Example: O-360-A1G6) are equipped with crankshafts with pendulum type counterweights attached.

TABLE 1

MODEL APPLICATION			
Model	Left**	Right**	Carburetor
<u>O-360</u>			
-A1A, -A2A, -A3A, -A4A	S4LN-21	S4LN-20	MA-4-5
-A1C, -C2D	S4LN-200	S4LN-204	PSH-5BD
-A1D, -A2D, -A3D, -A4D, -A2E	S4LN-200	S4LN-204	MA-4-5
-A1F, -A2F, -A1F6	S4LN-1227	S4LN-1209	MA-4-5
-A1G, -A2G, -A4G, -A1G6	S4LN-1227	S4LN-1209	HA-6
-A1H, -A2H, -A4J	S4LN-21	S4LN-204	HA-6
-A1H6	4273	4270	HA-6
-A1P, -A4P, -B2C, -C4P	4373	4370	MA-4-5
-A4K, -C1F, -C4F	4371	4370	HA-6
-A4M	4371	4370	MA-4-5

* - Models with counterclockwise rotation employ S4RN series.

** - See latest revision of Service Instruction No. 1443 for alternate magnetos.

**SECTION 1
DESCRIPTION**

**LYCOMING OPERATOR'S MANUAL
O-360 AND ASSOCIATED MODELS**

TABLE 1 (CONT.)

MODEL APPLICATION			
Model	Left**	Right**	Carburetor
<u>O-360 (Cont.)</u>			
-A4N	4251	4251	MA-4-5
-B1A, -B2A, -C1A, -C1G, -C2A	S4LN-21	S4LN-20	MA-4-5
-B1B, -B2B, -C1C, -C2C	S4LN-200	S4LN-204	MA-4-5
-C1E, -C2E, -A4M	4051	4050	MA-4-5
-C2B	S4LN-21	S4LN-20	PSH-5BD
-D1A, -D2A	S4LN-21	S4LN-20	MA-4-5
-D2B	S4LN-200	S4LN-204	MA-4-5
-F1A6	4191	4191	HA-6
-G1A6	4251	4251	HA-6
-J2A	4347	4370	MA-4SPA
<u>O-360 Dual Magneto</u>			
-A1AD, -A3AD, -A5AD		D4LN-3021	MA-4-5
-A1F6D, -A1LD		D4LN-3021	MA-4-5
-A1G6D		D4LN-3021	HA-6
<u>HO-360</u>			
-A1A	S4LN-200	S4LN-204	MA-4-5AA
-B1A	S4LN-200	S4LN-204	PSH-5BD
-B1B	S4LN-200	S4LN-200	PSH-5BD
-C1A	4347	4370	HA-6
<u>HIO-360</u>			
-A1A, -B1A, -B1B	S4LN-200	S4LN-200	RSA-5AB1
-A1B, -C1A	S4LN-200	S4LN-204	RSA-5AD1
-C1B	S4LN-1208	S4LN-1209	RSA-5AD1
-D1A	S4LN-1208	S4LN-1208	RSA-7AA1
-G1A	4347	4370	RSA-5AD1
<u>HIO-360 Dual Magneto</u>			
-E1AD		D4LN-3021	RSA-5AB1
-E1BD, -F1AD		D4LN-3200	RSA-5AB1
<u>IO-360</u>			
-A1A, -A2A, -B1B, -B1C	S4LN-200	S4LN-204	RSA-5AD1
-A1B, -A2B, -A1B6	S4LN-1227	S4LN-1209	RSA-5AD1
-A1C, -A2C, -C1B	S4LN-1208	S4LN-1209	RSA-5AD1
-A1D6, -B1E, -B2E	S4LN-1227	S4LN-1209	RSA-5AD1
-A3B6	4372	4370	RSA-5AD1

* - Models with counterclockwise rotation employ S4RN series.

** - See latest revision of Service Instruction No. 1443 for alternate magnetos.

TABLE 1 (CONT.)

MODEL APPLICATION			
Model	Left**	Right**	Fuel Injector
<u>IO-360 (Cont.)</u>			
-B1A	S4LN-200	S4LN-204	530
-B1D, -C1A	S4LN-200	S4LN-204	RSA-5AD1
-B1F, -B2F, -B2F6	S4LN-1227	S4LN-1227	RSA-5AD1
-B4A, -K2A	S4LN-21	S4LN-20	RSA-5AD1
-C1C, -C1C6, -C1D6	S4LN-1227	S4LN-1209	RSA-5AD1
-C1E6, -C1F, -F1A	S4LN-1227	S4LN-1209	RSA-5AD1
-D1A, -E1A	S4LN-1208	S4LN-1209	RSA-5AD1
-A1D	S4LN-21	S4LN-204	RSA-5AD1
-L2A	4371	4371	RSA-5AD1
◆, -M1B, -B1G6	4371	4370	RSA-5AD1
-C1G6	4345	4345	RSA-5AD1
<u>IO-360 Dual Magneto</u>			
-A1B6D, -A3B6D, -J1AD, -J1A6D		D4LN-3021	RSA-5AD1
-A1D6D, -A3D6D		D4LN-3000	RSA-5AD1
<u>AIO-360</u>			
-A1A, -A2A	S4LN-1208	S4LN-1209	RSA-5AD1
-A1B, -A2B, -B1B	S4LN-1227	S4LN-1209	RSA-5AD1
<u>TIO-360</u>			
-A1A, -A1B, -A3B6	S4LN-1208	S4LN-1209	RSA-5AD1
<u>TIO-360 Dual Magneto</u>			
-C1A6D		D4LN-3021	RSA-5AD1

* - Models with counterclockwise rotation employ S4RN series.

** - See latest revision of Service Instruction No. 1443 for alternate magnetos.

◆ - For information pertaining to engine model (L)IO-360-M1A, refer to Operation and Installation Manual P/N 60297-36

Engine models with letter "D" as 4th or 5th character in suffix denotes dual magnetos in single housing. Basic models employing -21 or -1227 (impulse coupling magnetos) use D4LN or D4RN-3021. Basic models employing -200 and -1208 (retard breaker magnetos) use D4LN or D4RN-3000. Example – Basic model IO-360-C1C uses S4LN-1227 and S4LN-1209, therefore model IO-360-C1CD would employ D4LN-3021.

This Page Intentionally Left Blank

LYCOMING OPERATOR'S MANUAL

SECTION 2 SPECIFICATIONS

Page

Specifications

O-360-A, -C, -F	2-1
O-360-B, -D	2-1
O-360-J2A	2-1
HO-360-A, -C	2-2
HO-360-B	2-2
IO-360-L2A	2-2
IO-360-B1G6, ♦, -M1B	2-3
IO-360-A, -C, -D, -J, -K	2-3
IO-360-B, -E, -F	2-4
AIO-360-A, -B	2-4
HIO-360-A, -B	2-4
HIO-360-C	2-5
HIO-360-D	2-5
HIO-360-E	2-5
HIO-360-F1AD	2-6
HIO-360-G1A	2-6
TIO-360-A	2-6
TIO-360-C	2-7
Accessory Drives	2-7
Detail Weights	2-7
Dimensions	2-9

♦ - For information pertaining to engine model (L)IO-360-M1A, refer to Operation and Installation Manual P/N 60297-36.

Revised March 2009

This Page Intentionally Left Blank

SECTION 2

SPECIFICATIONS

O-360-A, -C, -F Series*

FAA Type Certificate	286
Rated horsepower.....	180
Rated speed, RPM.....	2700
Bore, inches.....	5.125
Stroke, inches.....	4.375
Displacement, cubic inches.....	361.0
Compression ratio	8.5:1
Firing order	1-3-2-4
Spark occurs, degrees BTC.....	25
Valve rocker clearance (hydraulic tappets collapsed)028-.080
Propeller drive ratio	1-1
Propeller driven rotation (viewed from rear).....	Clockwise

* - O-360-C2D only. Take-off rating 180 HP @ 2900 RPM and 28 in. hg.

O-360-B, -D Series

FAA Type Certificate	286
Rated horsepower.....	168
Rated speed, RPM.....	2700
Bore, inches.....	5.125
Stroke, inches.....	4.375
Displacement, cubic inches.....	361.0
Compression ratio	7.2:1
Firing order	1-3-2-4
Spark occurs, degrees BTC.....	25
Valve rocker clearance (hydraulic tappets collapsed)028-.080
Propeller drive ratio	1:1
Propeller driven rotation (viewed from rear).....	Clockwise

O-360-J2A

FAA Type Certificate	286
Rated horsepower.....	145
Rated speed, RPM.....	2400 thru 2700
Bore, inches.....	5.125
Stroke, inches.....	4.375
Displacement, cubic inches.....	361.0
Compression ratio	8.5:1
Firing order	1-3-2-4
Spark occurs, degrees BTC.....	25
Valve rocker clearance (hydraulic tappets collapsed)028-.080
Propeller drive ratio	1:1
Propeller driven rotation (viewed from rear).....	Clockwise

**SECTION 2
SPECIFICATIONS**

**LYCOMING OPERATOR'S MANUAL
O-360 AND ASSOCIATED MODELS**

SPECIFICATIONS (CONT.)

HO-360-A, -C

FAA Type Certificate	286
Rated horsepower.....	180
Rated speed, RPM.....	2700
Bore, inches.....	5.125
Stroke, inches.....	4.375
Displacement, cubic inches.....	361.0
Compression ratio	8.5:1
Firing order	1-3-2-4
Spark occurs, degrees BTC.....	25
Valve rocker clearance (hydraulic tappets collapsed)028-.080
Propeller drive ratio	1:1
Propeller driven rotation (viewed from rear).....	Clockwise

HO-360-B Series

FAA Type Certificate	286
Rated horsepower.....	180
Rated speed, RPM.....	2900
Bore, inches.....	5.125
Stroke, inches.....	4.375
Displacement, cubic inches.....	361.0
Compression ratio	8.5:1
Firing order	1-3-2-4
Spark occurs, degrees BTC.....	25
Valve rocker clearance (hydraulic tappets collapsed)028-.080
Propeller drive ratio	1:1
Propeller driven rotation (viewed from rear).....	Clockwise

IO-360-L2A*

FAA Type Certificate	1E10
Rated horsepower.....	160
Rated speed, RPM.....	2400
Bore, inches.....	5.125
Stroke, inches.....	4.375
Displacement, cubic inches.....	361.0
Compression ratio	8.5:1
Firing order	1-3-2-4
Spark occurs, degrees BTC.....	25
Valve rocker clearance (hydraulic tappets collapsed)028-.080
Propeller drive ratio	1:1
Propeller driven rotation (viewed from rear).....	Clockwise

* - This engine has an alternate rating of 180 HP at 2700 RPM.

SPECIFICATIONS (CONT.)

IO-360-B1G6, ♦. -M1B*

FAA Type Certificate	1E10
Rated horsepower.....	180
Rated speed, RPM.....	2700
Bore, inches.....	5.125
Stroke, inches.....	4.375
Displacement, cubic inches.....	361.0
Compression ratio	8.5:1
Firing order	1-3-2-4
Spark occurs, degrees BTC.....	25
Valve rocker clearance (hydraulic tappets collapsed)028-.080
Propeller drive ratio	1:1
Propeller driven rotation (viewed from rear).....	Clockwise

♦ - For information pertaining to engine model (L)IO-360-M1A, refer to Operation and Installation Manual P/N 60297-36.

* - This engine has an alternate rating of 160 HP at 2400 RPM.

IO-360-A, -C, -D, -J, -K Series

FAA Type Certificate	1E10
Rated horsepower.....	200
Rated speed, RPM.....	2700
Bore, inches.....	5.125
Stroke, inches.....	4.375
Displacement, cubic inches.....	361.0
Compression ratio	8.7:1
Firing order	1-3-2-4
Spark occurs, degrees BTC.....	25**
Valve rocker clearance (hydraulic tappets collapsed)028-.080
Propeller drive ratio	1:1
Propeller driven rotation (viewed from rear).....	Clockwise

NOTE**

On the following model engines, the magneto spark occurs at 20° BTC. Consult nameplate before timing magnetos.

Models	Serial No.
IO-360-A Series (Except -A1B6D)	L-14436-51 and up
IO-360-C, -D Series (Except -C1C, -C1F, -C1C6, -C1D6)	L-14436-51 and up
IO-360-C1C, -C1F	L-13150-51 and up
IO-360-C1D6	L-14446-51 and up
LIO-360-C1E6	L-1064-67 and up
AIO-360-A1A, -A1B, -B1B	L-220-63 and up
HIO-360-C1A, -C1B	L-14436-51 and up
IO-360-C1C6	All Engines
IO-360-C1G6	All Engines
IO-360-J1AD, -K2A	All Engines

**SECTION 2
SPECIFICATIONS**

**LYCOMING OPERATOR'S MANUAL
O-360 AND ASSOCIATED MODELS**

SPECIFICATIONS (CONT.)

IO-360-B, -E, -F Series*

FAA Type Certificate	1E10
Rated horsepower.....	180
Rated speed, RPM.....	2700
Bore, inches.....	5.125
Stroke, inches.....	4.375
Displacement, cubic inches.....	361.0
Compression ratio	8.5:1
Firing order	1-3-2-4
Spark occurs, degrees BTC.....	25
Valve rocker clearance (hydraulic tappets collapsed)028-.080
Propeller drive ratio	1:1
Propeller driven rotation (viewed from rear).....	Clockwise

* - IO-360-B1C only is rated at 177 HP.

AIO-360-A, -B Series

FAA Type Certificate	1E10
Rated horsepower.....	200
Rated speed, RPM.....	2700
Bore, inches.....	5.125
Stroke, inches.....	4.375
Displacement, cubic inches.....	361.0
Compression ratio	8.7:1
Firing order	1-3-2-4
Spark occurs, degrees BTC.....	25**
Valve rocker clearance (hydraulic tappets collapsed)028-.080
Propeller drive ratio	1:1
Propeller driven rotation (viewed from rear).....	Clockwise

** - See Note Page 2-3.

HIO-360-A, -B Series

FAA Type Certificate	1E10
Rated horsepower.....	180*
Rated speed, RPM.....	2900
Bore, inches.....	5.125
Stroke, inches.....	4.375
Displacement, cubic inches.....	361.0
Compression ratio, -A series.....	8.7:1
Compression ratio, -B series.....	8.5:1
Firing order	1-3-2-4
Spark occurs, degrees BTC.....	25
Valve rocker clearance (hydraulic tappets collapsed)028-.080
Propeller drive ratio	1:1
Propeller driven rotation (viewed from rear).....	Clockwise

* - HIO-360-A has a rating of 180 HP at 26.1 Hg. manifold at standard sea level conditions to 3900 feet standard altitude with 25 in. Hg. manifold pressure.

SPECIFICATIONS (CONT.)

HIO-360-C Series

FAA Type Certificate	1E10
Rated horsepower.....	205
Rated speed, RPM.....	2900
Bore, inches.....	5.125
Stroke, inches.....	4.375
Displacement, cubic inches.....	361.0
Compression ratio	8.7:1
Firing order	1-3-2-4
Spark occurs, degrees BTC.....	25**
Valve rocker clearance (hydraulic tappets collapsed)028-.080
Propeller drive ratio	1:1
Propeller driven rotation (viewed from rear).....	Clockwise

** - See Note Page 2-3.

HIO-360-D Series

FAA Type Certificate	1E10
Rated horsepower.....	190
Rated speed, RPM.....	3200
Bore, inches.....	5.125
Stroke, inches.....	4.375
Displacement, cubic inches.....	361.0
Compression ratio	10.0:1
Firing order	1-3-2-4
Spark occurs, degrees BTC.....	20
Valve rocker clearance (hydraulic tappets collapsed)	*.028-.080
Propeller drive ratio	1:1
Propeller driven rotation (viewed from rear).....	Clockwise

* - Consult Service Bulletin No. 402 for valve rocker clearance of HIO-360-D1A.

HIO-360-E Series*

FAA Type Certificate	1E10
Rated horsepower.....	190
Rated speed, RPM.....	2900
Bore, inches.....	5.125
Stroke, inches.....	4.375
Displacement, cubic inches.....	361.0
Compression ratio	8.1:1
Firing order	1-3-2-4
Spark occurs, degrees BTC.....	20
Valve rocker clearance (hydraulic tappets collapsed)028-.080
Propeller drive ratio	1:1
Propeller driven rotation (viewed from rear).....	Clockwise

* - HIO-360-E has a rating of 205 HP at 2900 RPM and 36.5 in. Hg. manifold pressure when equipped with turbocharger kit SK-28-121000 or equivalent.

**SECTION 2
SPECIFICATIONS**

**LYCOMING OPERATOR'S MANUAL
O-360 AND ASSOCIATED MODELS**

SPECIFICATIONS (CONT.)

HIO-360-F1AD Series

FAA Type Certificate	1E10
Rated horsepower.....	190
Rated speed, RPM.....	3050
Bore, inches.....	5.125
Stroke, inches.....	4.375
Displacement, cubic inches.....	361.0
Compression ratio	8.0:1
Firing order	1-3-2-4
Spark occurs, degrees BTC.....	20
Valve rocker clearance (hydraulic tappets collapsed)028-.080
Propeller drive ratio	1:1
Propeller driven rotation (viewed from rear).....	Clockwise

HIO-360-G1A

FAA Type Certificate	1E10
Rated horsepower.....	180
Rated speed, RPM.....	2700
Bore, inches.....	5.125
Stroke, inches.....	4.375
Displacement, cubic inches.....	361.0
Compression ratio	8.5:1
Firing order	1-3-2-4
Spark occurs, degrees BTC.....	25
Valve rocker clearance (hydraulic tappets collapsed)028-.080
Propeller drive ratio	1:1
Propeller drive rotation (viewed from rear).....	Clockwise

TIO-360-A Series

FAA Type Certificate	E16EA
Rated horsepower.....	200
Rated speed, RPM.....	2575
Bore, inches.....	5.125
Stroke, inches.....	4.375
Displacement, cubic inches.....	361.0
Compression ratio	7.3:1
Firing order	1-3-2-4
Spark occurs, degrees BTC.....	20
Valve rocker clearance (hydraulic tappets collapsed)028-.080
Propeller drive ratio	1:1
Propeller driven rotation (viewed from rear).....	Clockwise

TIO-360-C Series

FAA Type Certificate	E16EA
Rated horsepower.....	210
Rated speed, RPM.....	2575
Bore, inches.....	5.125
Stroke, inches.....	4.375
Displacement, cubic inches.....	361.0
Compression ratio	7.3:1
Firing order	1-3-2-4
Spark occurs, degrees BTC.....	20
Valve rocker clearance (hydraulic tappets collapsed)028-.080
Propeller drive ratio	1:1
Propeller driven rotation (viewed from rear).....	Clockwise

*Accessory Drive	Drive Ratio	**Direction of Rotation
Starter	16.556:1	Counterclockwise
Generator	1.910:1	Clockwise
Generator	2.500:1	Clockwise
Alternator***	3.20:1	Clockwise
Tachometer	0.500:1	Clockwise
Magneto	1.000:1	Clockwise
Vacuum Pump	1.300:1	Counterclockwise
Propeller Governor (Rear Mounted)	0.866:1	Clockwise
Propeller Governor (Front Mounted)	0.895:1	Clockwise
Fuel Pump AN20010	0.866:1	Counterclockwise
Fuel Pump AN20003†	1.000:1	Counterclockwise
Fuel Pump – Plunger Operated Dual Drives	0.500:1	
Vacuum – Hydraulic Pump	1.300:1	Counterclockwise
Vacuum – Prop. Governor	1.300:1	Counterclockwise

* - When applicable.

** - Viewed facing drive pad.

*** - HIO-360-D1A – Alternator drive is 2.50:1.

† - TIO-360-C1A6D, HIO-360-E, -F have clockwise fuel pump drive.

NOTE

Engines with letter “L” in prefix will have opposite rotation to the above.

DETAIL WEIGHTS

1. ENGINE, STANDARD, DRY WEIGHT.

Includes carburetor or fuel injector, magnetos, spark plugs, ignition harness, intercylinder baffles, tachometer drive, starter and generator or alternator drive, starter and generator or alternator with mounting bracket. Turbocharged models include turbocharger, mounting bracket, exhaust manifold, controls, oil lines and baffles.

DETAIL WEIGHTS (CONT.)

Model	Lbs.
<u>O-360 Series</u>	
-C4P*	275
-D2A	282
-B2A, -B2C	284
-C1E, -C2E	285
-A1AD, -A3AD, -C1F, -C2D	288
-A1C, -A1D, -A2D, -A3D, -C2B, -C2C, -J2A	289
-A1A, -A2A, -A3A, -A1LD, -C1A, -C2A	290
-A2F	291
-A1P, -C1G	292
-A1G, -A2G	293
-A1H	294
-A4M, -A4P, -A1F6D, -C4F	295
-A4K, -A4N, -A5AD	296
-A4D, -A1G6D	297
-A4A, -A1F6, -A1H6	298
-A4J, -A1G6, -F1A6	300
-A4G	301
-G1A6	303
* - Weight does not include alternator.	
<u>HO-360 Series</u>	
-A1A	285
-B1A, -B1B, -C1A	288
<u>IO-360 Series</u>	
-L2A	278
-B1C	289
-B1A	295
-B1E	296
-B1D	297
-B1B	299
◆, -M1B	300
-B1F, -B2F	301
-B1G6	305
-B4A	307
-B2F6	308
-K2A	311
-A1D6D, -A3D6D, -C1A	319
-C1B	320
-C1C, -D1A	322
-J1AD	323
◆ - For information pertaining to engine model (L)IO-360-M1A, refer to Operation and Installation Manual P/N 60297-36.	

DETAIL WEIGHTS (CONT.)

Model	Lbs.
<u>IO-360 Series (Cont.)</u>	
-A1A, -A2A, -C1F, -C1G6	324
-A1C, -A2A, -A1D	325
-A1B, -A2B	326
-C1D6	328
-C1C6	329
-A1B6D, -A3B6D, -J1A6D	330
-A1B6, -A3B6	333
-A1D6	335
-C1E6	337
<u>AIO-360 Series</u>	
-A1A, -A2A	331
-A1B, -A2B, -B1B	332
<u>HIO-360 Series</u>	
-G1A	283
-B1A, -B1B	290
-A1A	311
-A1B	312
-D1A, -E1AD, -E1BD	321
-C1A	322
-C1B	323
-F1AD	324
<u>TIO-360 Series</u>	
-C1A6D	379
-A1A, -A1B	386
-A3B6	407

DIMENSIONS, INCHES

MODEL	HEIGHT	WIDTH	LENGTH
<u>O-360 Series</u>			
-A1A, -A1P, -A2A	24.59	33.37	29.56
-A1C	19.68	33.37	30.67
-A1D, -A2D	24.59	33.37	29.81
-A1F, -A2F	24.59	33.37	30.70
-A1F6	24.59	33.37	30.70
-A1G, -A2G	19.22	33.37	31.82
-A1H, -A2H	19.22	33.37	31.82

**SECTION 2
SPECIFICATIONS**

**LYCOMING OPERATOR'S MANUAL
O-360 AND ASSOCIATED MODELS**

DIMENSIONS, INCHES (CONT.)

MODEL	HEIGHT	WIDTH	LENGTH
<u>O-360 Series (Cont.)</u>			
-A1H6	19.33	33.38	31.81
-A3A, -A4A, -A4M, -A4P	24.59	33.37	29.56
-A3D, -A4D, -A2E	24.59	33.37	29.81
-A4G, -A4J, -A4K	19.22	33.37	31.82
-A1G6, -A1G6D, -C1F, -C4F	19.22	33.37	31.82
-A4N	24.59	33.37	29.05
-A1AD, -A3AD, -A5AD	24.59	33.37	31.33
-A1A5D, -A1F6D, -A1LD	24.59	33.37	31.33
-B1A, -B2A, -B2C	24.68	33.37	29.56
-B1B, -B2B	24.68	33.37	29.81
-C1A, -C2A	24.72	33.37	29.56
-C1C, -C2C, -C4P	24.59	33.37	29.81
-C1E, -C2E	24.59	33.37	29.05
-C2B, -C2D	19.68	33.37	30.67
-C1G, -D1A, -D2A	24.59	33.37	29.56
-D2B	24.59	33.37	29.81
-J2A	22.99	32.24	29.81
-F1A6	19.96	33.38	31.81
-G1A6	19.96	33.37	31.83
<u>HO-360 Series</u>			
-A1A	24.59	33.37	29.81
-B1A, -B1B	19.68	33.37	30.67
-C1A	19.22	33.37	31.82
<u>IO-360 Series</u>			
-A1A, -A2A, -A1D	19.35	34.25	29.81
-A1B, -A2B	19.35	34.25	30.70
-A1B6, -A3B6	19.35	34.25	30.70
-A1C, -A2C	19.35	34.25	29.30
-A1D6	19.35	34.25	30.70
-A1B6D, -A3B6D, -J1AD	19.35	34.25	31.33
-A1D6D, -A3D6D	19.35	34.25	31.33
-B1A	22.47	33.37	32.81
-B1B, -B1D, -L2A	24.84	33.37	29.81
-B1C	20.70	33.37	30.68
-B1E	20.70	33.37	32.09
-B1F, -B2F, -B2F6	24.84	33.37	30.70
-B4A	24.84	33.37	29.56
-C1A, -C1B	19.48	34.25	31.14
-C1C, -C1C6	19.48	34.25	33.65
-C1E6, -C1F	19.48	34.25	33.65

DIMENSIONS, INCHES (CONT.)

MODEL	HEIGHT	WIDTH	LENGTH
<u>IO-360 Series (Cont.)</u>			
-D1A, -C1D6, -C1G6	19.48	34.25	31.14
-E1A, -F1A, -B1G6	20.70	33.37	32.09
-K2A	19.35	34.25	29.81
◆, -M1B	20.26	33.38	32.75
<u>AIO-360 Series</u>			
-A1A, -A2A	20.76	34.25	30.08
-A1B, -A2B	20.76	34.25	30.08
-B1B	20.76	34.25	30.08
<u>HIO-360 Series</u>			
-A1A, -A1B	19.48	35.25	33.65
-B1A	19.38	33.37	32.09
-B1B	19.38	33.37	30.68
-C1A, -C1B	19.48	34.25	31.14
-D1A	19.48	35.25	35.28
-G1A	19.68	33.37	31.81
-E1AD, -A1BD, -F1AD	19.97	34.25	31.36
<u>TIO-360 Series</u>			
-A1A	21.43	34.25	45.41
-A1B, -A3B6	19.92	34.25	45.41
-C1A6D	21.65	19.09	35.82

◆ - For information pertaining to engine model (L)IO-360-M1A, refer to Operation and Installation Manual P/N 60297-36.

This Page Intentionally Left Blank

LYCOMING OPERATOR'S MANUAL

SECTION 3 OPERATING INSTRUCTIONS

	Page
General.....	3-1
Prestarting Items of Maintenance	3-1
Starting Procedures	3-1
Cold Weather Starting	3-3
Ground Running and Warm-Up	3-3
Ground Check	3-4
Operation in Flight	3-5
Engine Flight Chart	3-10
Operating Conditions	3-11
Shut Down Procedure.....	3-16
Performance Curves	3-17

This Page Intentionally Left Blank

SECTION 3

OPERATING INSTRUCTIONS

1. *GENERAL.* Close adherence to these instructions will greatly contribute to long life, economy and satisfactory operation of the engine.

NOTE

YOUR ATTENTION IS DIRECTED TO THE WARRANTIES THAT APPEAR IN THE FRONT OF THIS MANUAL REGARDING ENGINE SPEED, THE USE OF SPECIFIED FUELS AND LUBRICANTS, REPAIR AND ALTERATIONS. PERHAPS NO OTHER ITEM OF ENGINE OPERATION AND MAINTENANCE CONTRIBUTES QUITE SO MUCH TO SATISFACTORY PERFORMANCE AND LONG LIFE AS THE CONSTANT USE OF CORRECT GRADES OF FUEL AND OIL, CORRECT ENGINE TIMING, AND FLYING THE AIRCRAFT AT ALL TIMES WITHIN THE SPEED AND POWER RANGE SPECIFIED FOR THE ENGINE. DO NOT FORGET THAT VIOLATION OF THE OPERATION AND MAINTENANCE SPECIFICATIONS FOR YOUR ENGINE WILL NOT ONLY VOID YOUR WARRANTY BUT WILL SHORTEN THE LIFE OF YOUR ENGINE AFTER ITS WARRANTY PERIOD HAS PASSED.

New engines have been carefully run-in by Lycoming and therefore, no further break-in is necessary insofar as operation is concerned; however, new or newly overhauled engines should be operated on straight mineral oil for a minimum of 50 hours or until oil consumption has stabilized. After this period, a change to an approved additive oil may be made, if so desired.

NOTE

Cruising should be done at 65% to 75% power until a total of 50 hours has accumulated or oil consumption has stabilized. This is to ensure proper seating of the rings and is applicable to new engines, and engines in service following cylinder replacement or top overhaul of one or more cylinders.

The minimum fuel octane rating is listed in the flight chart, Part 8 of this section. Under no circumstances should fuel of a lower octane rating or automotive fuel (regardless of octane rating) be used.

2. *PRESTARTING ITEMS OF MAINTENANCE.* Before starting the aircraft engine for the first flight of the day, there are several items of maintenance inspection that should be performed. These are described in Section 4 under Daily Pre-Flight Inspection. They must be observed before the engine is started.

3. *STARTING PROCEDURES.* O-360, HO-360, IO-360, AIO-360, HIO-360, TIO-360 Series.

The following starting procedures are recommended, however, the starting characteristics of various installations will necessitate some variation from these procedures.

a. *Engines Equipped with Float Type Carburetors.*

(1) Perform pre-flight inspection.

**SECTION 3
OPERATING INSTRUCTIONS**

**LYCOMING OPERATOR'S MANUAL
O-360 AND ASSOCIATED MODELS**

- (2) Set carburetor heat control in "off" position.
- (3) Set propeller governor control in "Full RPM" position (where applicable).
- (4) Turn fuel valves "On".
- (5) Move mixture control to "Full Rich".
- (6) Turn on boost pump.
- (7) Open throttle approximately $\frac{1}{4}$ travel.
- (8) Prime with 1 to 3 strokes of manual priming pump or activate electric primer for 1 or 2 seconds.
- (9) Set magneto selector switch (consult airframe manufacturer's handbook for correct position).
- (10) Engage starter.
- (11) When engine fires, move the magneto switch to "Both".
- (12) Check oil pressure gage. If minimum oil pressure is not indicated within thirty seconds, stop engine and determine trouble.

b. Engines Equipped with Pressure Carburetors or Bendix Fuel Injectors.

- (1) Perform pre-flight inspection.
- (2) Set carburetor heat or alternate air control in "Off" position.
- (3) Set propeller governor control in "Full RPM" position (where applicable).
- (4) Turn fuel valve "On".
- (5) Turn boost pump "On".
- (6) Open throttle wide open, move mixture control to "Full Rich" until a slight but steady fuel flow is noted (approximately 3 to 5 seconds) then return throttle to "Closed" and return mixture control to "Idle Cut-Off".
- (7) Turn boost pump "Off".
- (8) Open throttle $\frac{1}{4}$ of travel.
- (9) Set magneto selector switch (consult airframe manufacturer's handbook for correct position).
- (10) Engage starter.

- (11) Move mixture control slowly and smoothly to "Full Rich".
- (12) Check oil pressure gage. If minimum oil pressure is not indicated within thirty seconds, stop engine and determine trouble.

c. Engines Equipped with Simmonds Type 530 Fuel Injector.

- (1) Perform pre-flight inspection.
- (2) Set alternate air control in "Off" position.
- (3) Set propeller governor control in "Full RPM" position.
- (4) Turn fuel valve "On".
- (5) Turn boost pump "On".
- (6) Open throttle approximately $\frac{1}{4}$ travel, move mixture control to "Full Rich" until a slight but steady fuel flow is noted (approximately 3 to 5 seconds) then return throttle to "Closed" and return mixture control to "Idle Cut-Off".
- (7) Turn boost pump "Off".
- (8) Open throttle $\frac{1}{4}$ travel.
- (9) Move combination magneto switch to "Start", using accelerator pump as a primer while cranking engine.
- (10) When engine fires allow the switch to return to "Both".
- (11) Check oil pressure gage. If minimum oil pressure is not indicated within thirty seconds, stop engine and determine trouble.

4. *COLD WEATHER STARTING.* During extreme cold weather, it may be necessary to preheat the engine and oil before starting.

5. *GROUND RUNNING AND WARM-UP.*

The engines covered in this manual are air-pressure cooled and depend on the forward speed of the aircraft to maintain proper cooling. Particular care is necessary, therefore, when operating these engines on the ground. To prevent overheating, it is recommended that the following precautions be observed.

NOTE

Any ground check that requires full throttle operation must be limited to three minutes, or less if the cylinder head temperature should exceed the maximum as stated in this manual.

**SECTION 3
OPERATING INSTRUCTIONS**

**LYCOMING OPERATOR'S MANUAL
O-360 AND ASSOCIATED MODELS**

a. Fixed Wing.

- (1) Head the aircraft into the wind.
- (2) Leave mixture in "Full Rich".
- (3) Operate only with the propeller in minimum blade angle setting.
- (4) Warm-up to approximately 1000-1200 RPM. Avoid prolonged idling and do not exceed 2200 RPM on the ground.
- (5) Engine is warm enough for take-off when the throttle can be opened without the engine faltering.
| Take-off with a turbocharged engine must not be started if indicated lubricating oil pressure, due to cold temperature is above maximum. Excessive oil pressure can cause overboost and consequent engine damage.

b. Helicopter.

- (1) Warm-up at approximately 2000 RPM with rotor engaged as directed in the airframe manufacturer's handbook.

6. GROUND CHECK.

- a. Warm-up as directed above.
- b. Check both oil pressure and oil temperature.
- c. Leave mixture control in "Full Rich".
- d. *Fixed Wing Aircraft (where applicable).* Move the propeller control through its complete range to check operation and return to full low pitch position. Full feathering check (twin engine) on the ground is not recommended but the feathering action can be checked by running the engine between | 1000-1500 RPM, then momentarily pulling the propeller control into the feathering position. Do not allow the RPM to drop more than 500 RPM.
- e. A proper magneto check is important. Additional factors, other than the ignition system, affect magneto drop-off. They are load-power output, propeller pitch, and mixture strength. The important point is that the engine runs smoothly because magneto drop-off is affected by the variables listed above. Make the magneto check in accordance with the following procedures.

(1) Fixed Wing Aircraft.

- | *(a) (Controllable pitch propeller).* With the propeller in minimum pitch angle, set the engine to produce 50-65% power as indicated by the manifold pressure gage unless otherwise specified in the aircraft manufacturer's manual. At these settings, the ignition system and spark plugs must work harder because of the greater pressure within the cylinders. Under these conditions, ignition problems can occur. Magneto checks at low power settings will only indicate fuel/air distribution quality.

- (b) (*Fixed pitch propeller*). Aircraft that are equipped with fixed pitch propellers, or not equipped with manifold pressure gage, may check magneto drop-off with engine operating at approximately 1800 RPM (2000 RPM maximum).
- (c) Switch from both magnetos to one and note drop-off; return to both until engine regains speed and switch to the other magneto and note drop-off, then return to both. Drop-off must not exceed 175 RPM and must not exceed 50 RPM between magnetos. Smooth operation of the engine but with a drop-off that exceeds the normal specification of 175 RPM is usually a sign of propeller load condition at a rich mixture. Proceed to step e. (1) (d).
- (d) If the RPM drop exceeds 175 RPM, slowly lean the mixture until the RPM peaks. Then retard the throttle to the RPM specified in step e.(1)(a) or e.(1)(b) for the magneto check and repeat the check. If the drop-off does not exceed 175 RPM, the difference between the magnetos does not exceed 50 RPM, and the engine is running smoothly, then the ignition system is operating properly. Return the mixture to full rich.

(2) *Helicopter.*

Raise collective pitch stick to obtain 15 inches manifold pressure at 2000 RPM.

Switch from both magnetos to one and note drop-off; return to both until engine regains speed and switch to the other magneto and note drop-off. Drop-off must not exceed 200 RPM. Drop-off between magnetos must not exceed 50 RPM. A smooth drop-off past normal is usually a sign of a too lean or too rich mixture.

- f. Do not operate on a single magneto for too long a period; a few seconds is usually sufficient to check drop-off and to minimize plug fouling.

7. *OPERATION IN FLIGHT.*

- a. See airframe manufacturer's instructions for recommended power settings.
- b. Throttle movements from full power to idle or from idle to full power are full range movements. Full range throttle movements must be performed over a minimum time duration of 2 to 3 seconds. Performing a full range throttle movement at a rate of less than 2 seconds is considered a rapid or instant movement. Performing rapid movements may result in detuned counterweights which may lead to failure of the counterweight lobes and subsequent engine damage.

c. *Fuel Mixture Leaning Procedure.*

Improper fuel/air mixture during flight is responsible for engine problems, particularly during take-off and climb power settings. The procedures described in this manual provide proper fuel/air mixture when leaning Lycoming engines; they have proven to be both economical and practical by eliminating excessive fuel consumption and reducing damaged parts replacement. It is therefore recommended that operators of all Lycoming aircraft engines utilize the instructions in this publication any time the fuel/air mixture is adjusted during flight.

Manual leaning may be monitored by exhaust gas temperature indication, fuel flow indication, and by observation of engine speed and/or airspeed. However, whatever instruments are used in monitoring the mixture, the following general rules must be observed by the operator of Lycoming aircraft engines.

GENERAL RULES

Never exceed the maximum red line cylinder head temperature limit.

For maximum service life, cylinder head temperatures should be maintained below 435°F (224°C) during high performance cruise operation and below 400°F (205°C) for economy cruise powers.

Do not manually lean engines equipped with automatically controlled fuel system.

On engines with manual mixture control, maintain mixture control in "Full Rich" position for rated take-off, climb, and maximum cruise powers (above approximately 75%). However, during take-off from high elevation airport or during climb, roughness or loss of power may result from over-richness. In such a case adjust mixture control only enough to obtain smooth operation – not for economy. Observe instruments for temperature rise. Rough operation due to over-rich fuel/air mixture is most likely to be encountered in carbureted engines at altitude above 5,000 feet.

Always return the mixture to full rich before increasing power settings.

Operate the engine at maximum power mixture for performance cruise powers and at best economy mixture for economy cruise power; unless otherwise specified in the airplane owner's manual.

During letdown flight operations it may be necessary to manually lean uncompensated carbureted or fuel injected engines to obtain smooth operation.

On turbocharged engines never exceed 1650°F turbine inlet temperature (TIT).

1. LEANING TO EXHAUST GAS TEMPERATURE GAGE.

a. Normally aspirated engines with fuel injectors or uncompensated carburetors.

(1) Maximum Power Cruise (approximately 75% power) – Never lean beyond 150°F on rich side of peak EGT unless aircraft operator's manual shows otherwise. Monitor cylinder head temperatures.

(2) Best Economy Cruise (approximately 75% power and below) – Operate at peak EGT.

b. Turbocharged engines.

(1) Best Economy Cruise – Lean to peak turbine inlet temperature (TIT) or 1650°F, whichever occurs first.

(2) Maximum Power Cruise – The engine must always be operated on the rich side of peak EGT or TIT. Before leaning to obtain maximum power mixture it is necessary to establish a reference point. This is accomplished as follows:

(a) Establish a peak EGT or TIT for best economy operation at the highest economy cruise power without exceeding 1650°F.

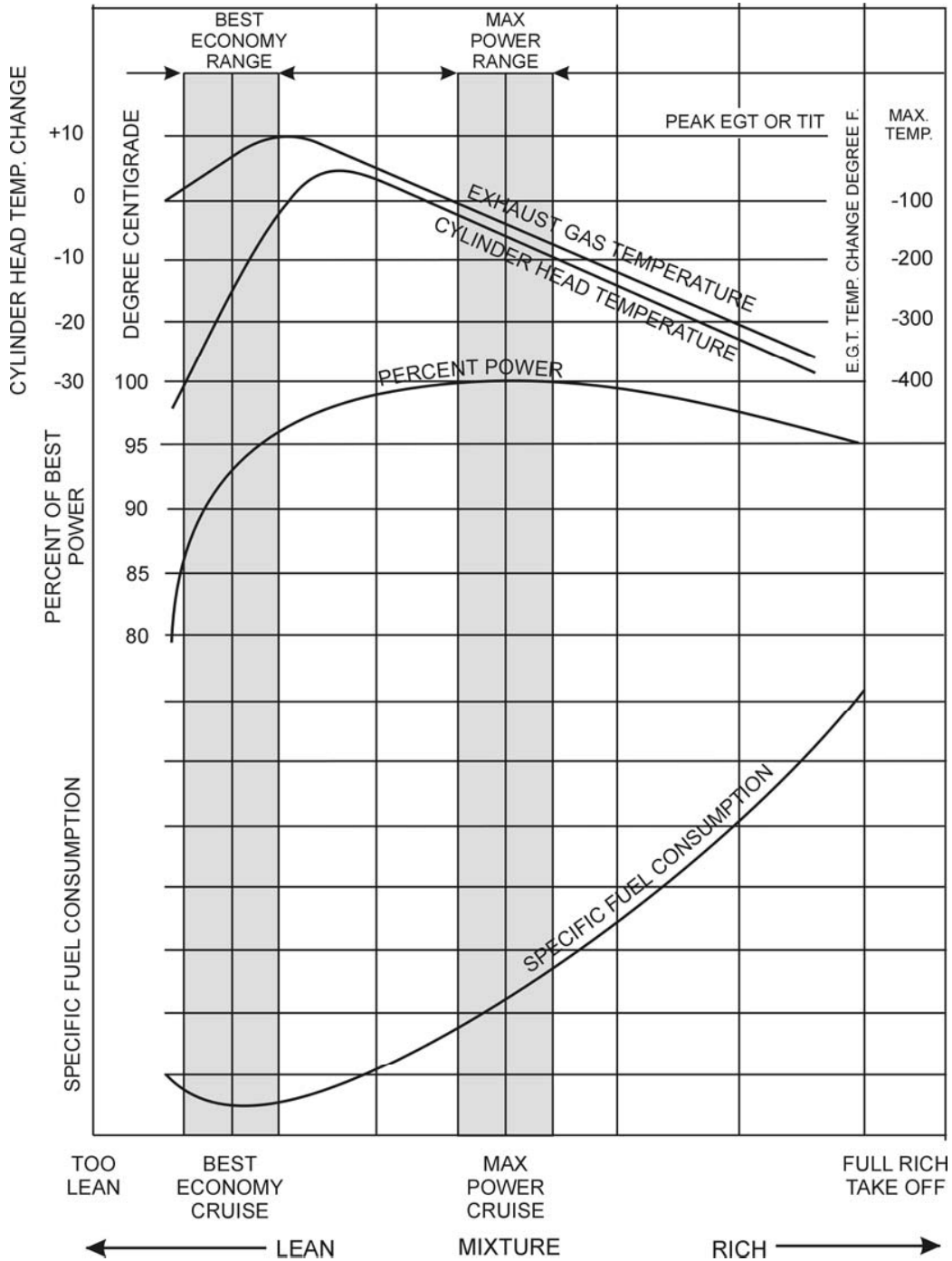

Figure 3-1. Representative Effect of Fuel/Air Ratio on Cylinder Head Temperature, Power and Specific Fuel Consumption at Constant RPM and Manifold Pressure in Cruise Range Operation

**SECTION 3
OPERATING INSTRUCTIONS**

**LYCOMING OPERATOR'S MANUAL
O-360 AND ASSOCIATED MODELS**

- (b) Deduct 125°F from this temperature and thus establish the temperature reference point for use when operating at maximum power mixture.
- (c) Return mixture control to full rich and adjust the RPM and manifold pressure for desired performance cruise operation.
- (d) Lean out mixture until EGT or TIT is the value established in step (b). This sets the mixture at best power.

2. LEANING TO FLOWMETER.

Lean to applicable fuel-flow tables or lean to indicator marked for correct fuel flow for each power setting.

3. LEANING WITH MANUAL MIXTURE CONTROL. (Economy cruise, 75% power or less, without flowmeter or EGT gauge.)

a. Carbureted Engines.

- (1) Slowly move mixture control from “Full Rich” position toward lean position.
- (2) Continue leaning until engine roughness is noted.
- (3) Enrich until engine runs smoothly and power is regained.

b. Fuel Injected Engines.

- (1) Slowly move mixture control from “Full Rich” position toward lean position.
- (2) Continue leaning until slight loss of power is noted (loss of power may or may not be accompanied by roughness).
- (3) Enrich until engine runs smoothly and power is regained.

WARNING

REFER TO THE PILOT'S OPERATING HANDBOOK OR AIRFRAME MANUFACTURER'S MANUAL FOR ADDITIONAL INSTRUCTIONS ON THE USE OF CARBURETOR HEAT CONTROL. INSTRUCTIONS FOUND IN EITHER PUBLICATION SUPERSEDE THE FOLLOWING INFORMATION.

- c. Use of Carburetor Heat Control** – Under certain moist atmospheric conditions (generally at a relative humidity of 50% or greater) and at temperatures of 20° to 90°F it is possible for ice to form in the induction system. Even in summer weather ice may form. This is due to the high air velocity through the carburetor venturi and the absorption of heat from this air by vaporization of the fuel. The temperature in the mixture chamber may drop as much as 70°F below the temperature of the incoming air. If this air contains a large amount of moisture, the cooling process can cause precipitation in the form of ice. Ice formation generally begins in the vicinity of the butterfly and may build up to such an extent that a drop in power output could result. In installations equipped with fixed pitch propellers, a loss of power is reflected by a drop in manifold pressure and RPM. In installations equipped with constant speed propellers, a loss of power is reflected by a drop in manifold pressure. If not corrected, this condition may cause complete engine stoppage.

To avoid this, all installations are equipped with a system for preheating the incoming air supply to the carburetor. In this way sufficient heat is added to replace the heat loss of vaporization of fuel, and the mixing chamber temperature cannot drop to the freezing point of water (32°F). The air preheater is a tube or jacket through which the exhaust pipe from one or more cylinders is passed, and the air flowing over these surfaces is raised to the required temperature before entering the carburetor. Consistently high temperatures are to be avoided because of a loss in power and a decided variation of mixture. High charge temperatures also favor detonation and preignition, both of which are to be avoided if normal service life is to be expected from the engine. The following outline is the proper method of utilizing the carburetor heat control.

- (1) *Ground Operation* – Use of the carburetor air heat on the ground must be held to an absolute minimum. On some installations the air does not pass through the air filter, and dirt and foreign substances can be taken into the engine with the resultant cylinder and piston ring wear. Only use carburetor air heat on the ground to make certain it is functioning properly.
- (2) *Take-Off* – Set the carburetor heat in full cold position. For take-off and full throttle operation the possibility of expansion or throttle icing at wide throttle openings is very remote.
- (3) *Climbing* – When climbing at part throttle power settings of 80% or above, set the carburetor heat control in the full cold position; however, if it is necessary to use carburetor heat to prevent icing it is possible for engine roughness to occur due to the over-rich fuel/air mixture produced by the additional carburetor heat. When this happens, lean the mixture with the mixture control only enough to produce smooth engine operation. Do not continue to use carburetor heat after flight is out of icing conditions, and return mixture to full rich when carburetor heat is removed.
- (4) *Flight Operation* – During normal flight, leave the carburetor air heat control in the full cold position. On damp, cloudy, foggy or hazy days, regardless of the outside air temperature, be alert for loss of power. This will be evidenced by an unaccountable loss in manifold pressure or RPM or both, depending on whether a constant speed or fixed pitch propeller is installed on the aircraft. If this happens, apply full carburetor air heat and open the throttle to limiting manifold pressure and RPM. This will result in a slight additional drop in manifold pressure, which is normal, and this drop will be regained as the ice is melted out of the induction system. When ice has been melted from the induction system, return the carburetor heat control to the full cold position. In those aircraft equipped with a carburetor air temperature gauge, partial heat may be used to keep the mixture temperature above the freezing point of water (32°F).

WARNING

CAUTION MUST BE EXERCISED WHEN OPERATING WITH PARTIAL HEAT ON AIRCRAFT THAT DO NOT HAVE A CARBURETOR AIR TEMPERATURE GAUGE. USE EITHER FULL HEAT OR NO HEAT IN AIRCRAFT THAT ARE NOT EQUIPPED WITH A CARBURETOR AIR TEMPERATURE GAUGE.

- (5) *Landing Approach* – In making a landing approach, the carburetor heat is generally in the “Full Cold” position. However, if icing conditions are suspected, apply “Full Heat”. In the case that full power needs to be applied under these conditions, as for an aborted landing, return the carburetor heat to “Full Cold” after full power application.

**SECTION 3
OPERATING INSTRUCTIONS**

**LYCOMING OPERATOR'S MANUAL
O-360 AND ASSOCIATED MODELS**

8. *ENGINE FLIGHT CHART.*

FUEL AND OIL –

Model Series	*Aviation Grade Fuel Minimum Grade
O-360-B, -D	80/87
O-360-A1P, -C1F, -C4F; HO-360-C1A	91/96
O-360-C, -F; HO-360-A, -B; IO-360-B, -E; HIO-360-B	91/96 or 100/130
O-360-J2A	91/96 or 100/100LL
IO-360-L2A, -M1A, -M1B	91/96 or 100LL
HIO-360-G1A	91/96 or 100LL
O-360-A, -C1G, -C4P, -A1H6; TIO-360-C1A6D	100/100LL
IO-360-B1G6, -C1G6, -J, -K2A, -A1D6D, -A3B6, -A3D6D; HIO-360-A1B	100/100LL
AIO-360-A, -B; IO-360-A, -C, -D, -F	100/130
HIO-360-A, -C, -D, -E, -F	100/130
TIO-360-A	100/130

NOTE

Aviation grade 100LL fuels in which the lead content is limited to 2 c.c. per gal. are approved for continuous use in the above listed engines.

* - Refer to latest revision of Service Instruction No. 1070.

FUEL PRESSURE, PSI –

Model	Max.	Desired	Min.
O-360 Series (Except -A1C, -C2B, -C2D); HO-360-A, -C Series Inlet to carburetor	8.0	3.0	0.5
O-360-A1C, -C2B, -C1D; HO-360-B Series Inlet to carburetor	18	13	9.0
HIO-360-A1B Inlet to fuel pump	30	-----	-2
IO-360 Series (Except -B1A, -F1A); AIO-360 Series, HIO-360 Series (Except -A1B) Inlet to fuel pump	35	-----	-2
IO-360-F1A Inlet to fuel pump	35	-----	-2
IO-360 Series (Except -B1A), AIO-360 Series; HIO-360 Series Inlet to fuel injector	45		14
IO-360-B1A Inlet to fuel injector	2		-2

FUEL PRESSURE, PSI (CONT.) –

Model	Max.	Desired	Max.
HIO-360-E, -F Series			
Inlet to fuel pump	55		-2
Inlet to fuel injector	55		27
TIO-360-A Series			
Inlet to fuel pump	50		-2
Inlet to fuel injector	45		20
TIO-360-C1A6D			
Inlet to fuel pump	65		-2
Inlet to fuel injector	65		22

OIL – (All Models) –

***Recommended Grade Oil**

Average Ambient Air	MIL-L-6082B Grades	MIL-L-22851 Ashless Dispersant Grades
All Temperatures	-----	SAE 15W-50 or 20W-50
Above 80°F	SAE 60	SAE60
Above 60°F	SAE 50	SAE 40 or SAE 50
30° to 90°F	SAE 40	SAE 40
0° to 70°F	SAE 30	SAE 40, 30 or 20W40
Below 10°F	SAE 20	SAE 30 or 20W30

* - Refer to latest revision of Service Instruction No. 1014.

OIL SUMP CAPACITY

I All Models (Except AIO-360 Series, O-360-J2A)	8 U.S. Quarts
Minimum Safe Quantity in Sump	
(Except – IO-360-M1A, -M1B; HIO-360-G1A)	2 U.S. Quarts
IO-360-M1A, -M1B; HIO-360-G1A	4 U.S. Quarts
AIO-360 Series	Dry Sump
I O-360-J2A.....	6 U.S. Quarts

OPERATING CONDITIONS

Average Ambient Air	Desired	*Oil Inlet Temperature Maximum
Above 80°F	180°F (82°C)	245°F (118°C)
Above 60°F	180°F (82°C)	245°F (118°C)
30° to 90°F	180°F (82°C)	245°F (118°C)
0° to 70°F	170°F (77°C)	245°F (118°C)
Below 10°F	160°F (71°C)	245°F (118°C)

* - Engine oil temperature should not be below 140°F (60°C) during continuous operation.

**SECTION 3
OPERATING INSTRUCTIONS**

**LYCOMING OPERATOR'S MANUAL
O-360 AND ASSOCIATED MODELS**

OPERATING CONDITIONS (CONT.)

Oil Pressure, psi (Rear)	Maximum	Minimum	Idling
Normal Operation, All Models (Except Below)	95	55	25
TIO-360-C1A6D	95	50	25
Oil Pressure, psi (Front)			
O-360-A4N, -F1A6	90	50	20
Start, Warm-up, Taxi, and Take-off (All Models)	115		

Operation	RPM	HP	Fuel Cons. Gal/Hr.	Max. Oil Cons. Qts./Hr.	*Max. Cyl. Head Temp.
O-360-A, -C** Series					
Normal Rated	2700	180	-----	.80	500°F (260°C)
Performance Cruise (75% Rated)	2450	135	10.5	.45	500°F (260°C)
Economy Cruise (65% Rated)	2350	117	9.5	.39	500°F (260°C)
O-360-B, -D Series					
Normal Rated	2700	168	-----	.75	500°F (260°C)
Performance Cruise (75% Rated)	2450	126	11.6	.42	500°F (260°C)
Economy Cruise (65% Rated)	2350	109	9.0	.37	500°F (260°C)
O-360-A1P, -A4D, -A4P, -C4P, -F, -G Series					
Normal Rated	2700	180	-----	.80	500°F (260°C)
Performance Cruise (75% Rated)	2450	135	9.7	.45	500°F (260°C)
Economy Cruise (65% Rated)	2350	117	8.3	.39	500°F (260°C)

* - At Bayonet Location – For maximum service life of the engine maintain cylinder head temperature between 150°F and 400°F during continuous operation.

** - O-360-C2D Only – Take-off rating 180 HP at 2900 RPM, 28 in. Hg.

OPERATING CONDITIONS (CONT.)

Operation	RPM	HP	Fuel Cons. Gal./Hr.	Max. Oil Cons. Qts./Hr.	*Max. Cyl. Head Temp.
O-360-J2A					
Normal Rated	2400/2700	145	-----	.50	500°F (260°C)
Performance Cruise (75% Rated)	1800/2025	109	9.3	.36	500°F (260°C)
Economy Cruise (65% Rated)	1560/1755	94	6.8	.31	500°F (260°C)
HO-360-A, -C Series; HIO-360-G1A					
Normal Rated	2700	180	-----	.80	500°F (260°C)
Performance Cruise (75% Rated)	2450	135	9.7	.45	500°F (260°C)
Economy Cruise (65% Rated)	2350	117	9.0	.39	500°F (260°C)
HO-360-B Series					
Normal Rated	2900	180	-----	.80	500°F (260°C)
Performance Cruise (75% Rated)	2700	135	10.5	.45	500°F (260°C)
Economy Cruise (65% Rated)	2700	117	9.0	.39	500°F (260°C)
IO-360-A, -C, -D, -J, -K; AIO-360 Series					
Normal Rated	2700	200	-----	.89	500°F (260°C)
Performance Cruise (75% Rated)	2450	150	12.3	.50	500°F (260°C)
Economy Cruise (65% Rated)	2350	130	9.5	.44	500°F (260°C)
IO-360-B, -E, -F Series (Except -B1C); IO-360-M1A**, -M1B**					
Normal Rated	2700	180	-----	.80	500°F (260°C)
Performance Cruise (75% Rated)	2450	135	11.0	.45	500°F (260°C)
Economy Cruise (65% Rated)	2350	117	8.5	.39	500°F (260°C)

* - At Bayonet Location – For maximum service life of the engine maintain cylinder head temperature between 150°F and 400°F during continuous operation.

** - This engine has an alternate rating of 160 HP at 2400 RPM.

**SECTION 3
OPERATING INSTRUCTIONS**

**LYCOMING OPERATOR'S MANUAL
O-360 AND ASSOCIATED MODELS**

OPERATING CONDITIONS (CONT.)

Operation	RPM	HP	Fuel Cons. Gal./Hr.	Max. Oil Cons. Qts./Hr.	*Max. Cyl. Head Temp.
IO-360-B1C					
Normal Rated	2700	177	-----	.79	500°F (260°C)
Performance Cruise (75% Rated)	2450	133	11.0	.45	500°F (260°C)
Economy Cruise (65% Rated)	2350	115	8.5	.39	500°F (260°C)
IO-360-L2A					
Normal Rated	2400	160	-----	.52	500°F (260°C)
Performance Cruise (75% Rated)	2180	120	8.8	.39	500°F (260°C)
Economy Cruise (65% Rated)	2080	104	7.6	.34	500°F (260°C)
HIO-360-A Series					
Normal Rated	2900	180†	-----	.80	500°F (260°C)
Performance Cruise (75% Rated)	2700	135	11.0	.45	500°F (260°C)
Economy Cruise (65% Rated)	2700	117	9.5	.39	500°F (260°C)
HIO-360-B Series					
Normal Rated	2900	180	-----	.80	500°F (260°C)
Performance Cruise (75% Rated)	2700	135	12.0	.45	500°F (260°C)
Economy Cruise (65% Rated)	2700	117	10.0	.39	500°F (260°C)
HIO-360-C Series					
Normal Rated	2900	205	-----	.91	500°F (260°C)
Performance Cruise (75% Rated)	2700	154	12.5	.52	500°F (260°C)
Economy Cruise (65% Rated)	2700	133	10.5	.45	500°F (260°C)

* - At Bayonet Location – For maximum service life of the engine maintain cylinder head temperature between 150°F and 400°F during continuous operation.

† - At 26 in. Hg. manifold pressure.

OPERATING CONDITIONS (CONT.)

Operation	RPM	HP	Fuel Cons. Gal./Hr.	Max. Oil Cons. Qts./Hr.	*Max. Cyl. Head Temp.
HIO-360-D Series					
Normal Rated Performance Cruise	3200	190	-----	.85	500°F (260°C)
(75% Rated)	3200	142	12.0	.48	500°F (260°C)
Economy Cruise (65% Rated)	3200	123	10.0	.41	500°F (260°C)
HIO-360-E Series					
Normal Rated Performance Cruise	2900	190	-----	.85	500°F (260°C)
(75% Rated)	2700	142	11.8	.47	500°F (260°C)
Economy Cruise (65% Rated)	2700	123	10.0	.41	500°F (260°C)
HIO-360-F Series					
Normal Rated Performance Cruise	3050	190	-----	.84	500°F (260°C)
(75% Rated)	2700	142	11.8	.47	500°F (260°C)
Economy Cruise (65% Rated)	2700	123	10.0	.46	500°F (260°C)
TIO-360-A Series**					
Normal Rated Performance Cruise	2700	200	-----	.89	500°F (260°C)
(75% Rated)	2450	150	14.0	.50	500°F (260°C)
Economy Cruise (65% Rated)	2350	130	10.2	.44	500°F (260°C)
TIO-360-C Series**					
Normal Rated Performance Cruise	2575	210	-----	.70	500°F (260°C)
(75% Rated)	2400	157.5	13.2	.53	500°F (260°C)
Economy Cruise (65% Rated)	2200	136.5	10.2	.46	500°F (260°C)

* - At Bayonet Location – For maximum service life of the engine maintain cylinder head temperature between 150°F and 400°F during continuous operation.

** - MAXIMUM TURBINE INLET TEMPERATURE 1650°F (898.8°C).

**SECTION 3
OPERATING INSTRUCTIONS**

**LYCOMING OPERATOR'S MANUAL
O-360 AND ASSOCIATED MODELS**

9. SHUT DOWN PROCEDURE.

a. Fixed Wing.

- (1) Set propeller governor control for minimum blade angle when applicable.
- (2) Idle until there is a decided drop in cylinder head temperature.
- (3) Move mixture control to "Idle Cut-Off".
- (4) When engine stops, turn off switches.

b. Helicopters.

- (1) Idle as directed in the airframe manufacturer's handbook, until there is a decided drop in cylinder head temperature.
- (2) Move mixture control to "Idle Cut-Off".
- (3) When engine stops, turn off switches.

**SEA LEVEL POWER CURVE
LYCOMING MODEL O-360-B and -D SERIES**

COMPRESSION RATIO 7.20:1
 SPARK ADVANCE 25° BTC
 CARBURETOR MARVEL-SCHEBLER MA-4-5
 FUEL GRADE, MINIMUM 80/87
 MIXTURE SETTING FULL RICH

C-10818

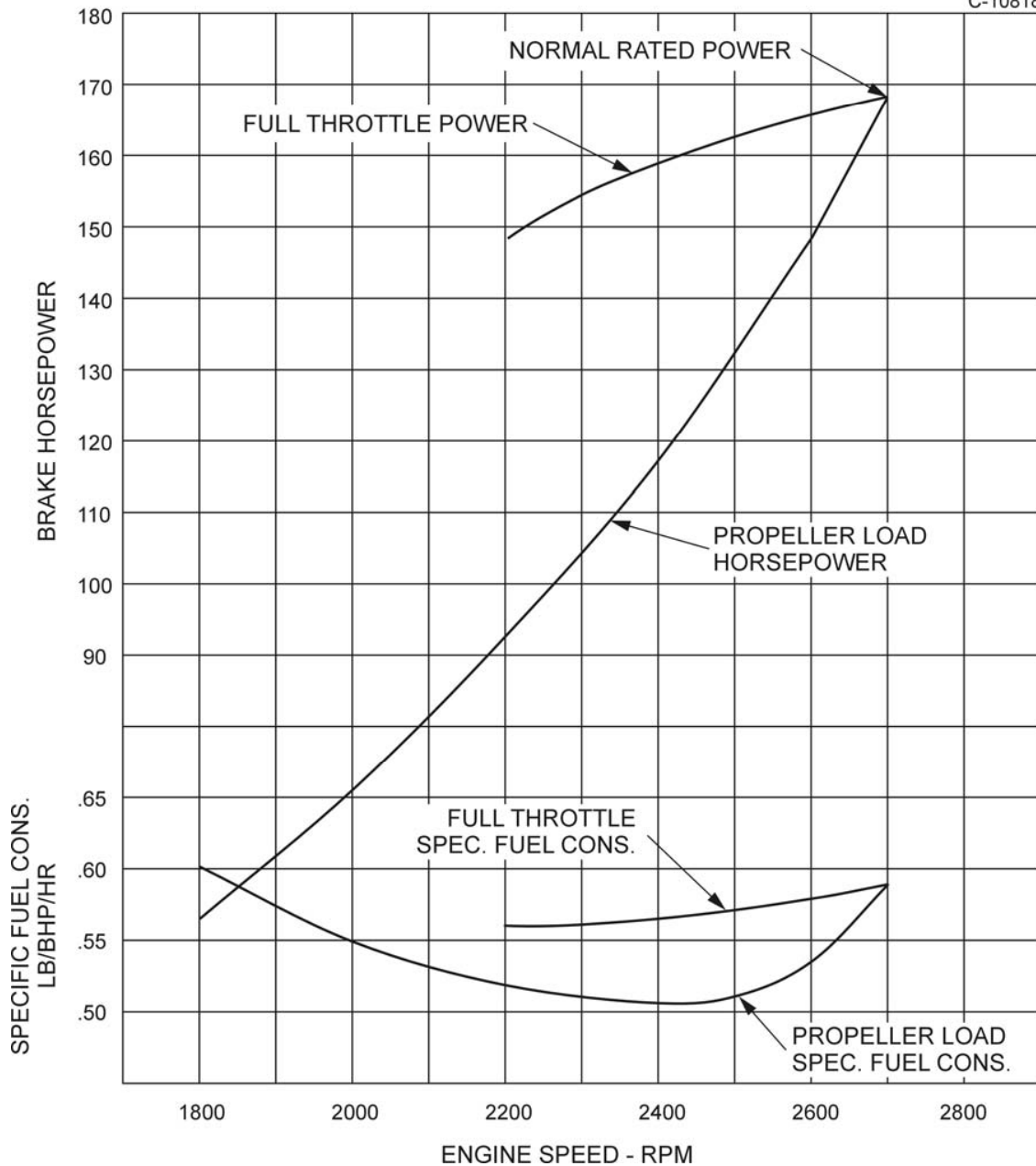

Figure 3-2. Power Curve – O-360-B, -D Series

PART THROTTLE FUEL CONSUMPTION
LYCOMING MODEL O-360-C2B and -C2D

CARBURATOR, BENDIX-STROMBERG PSH-5BD
 FUEL, MINIMUM GRADE 91/96
 MIXTURE SETTING FULL RICH
 COMPRESSION RATIO 8.50:1
 SPARK TIMING 25° BTC
 OPERATING CONDITIONS STD. SEA LEVEL
 FUEL CONSUMPTION TOLERANCE +/- 4%
 OPERATION WITH EXTERNAL COOLING SUPPLY

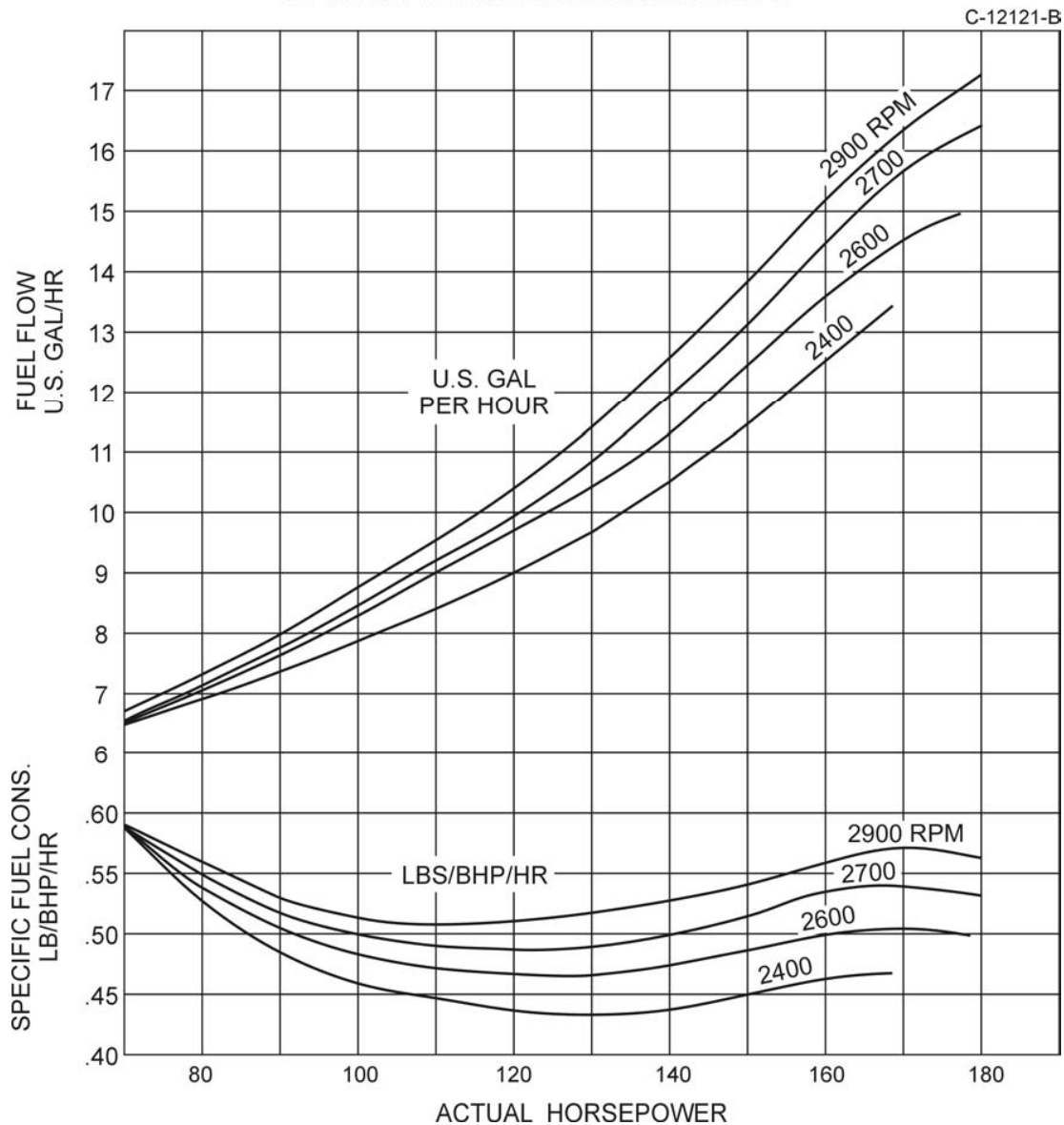

Figure 3-3. Part Throttle Fuel Consumption –
O-360-C2B, -C2D

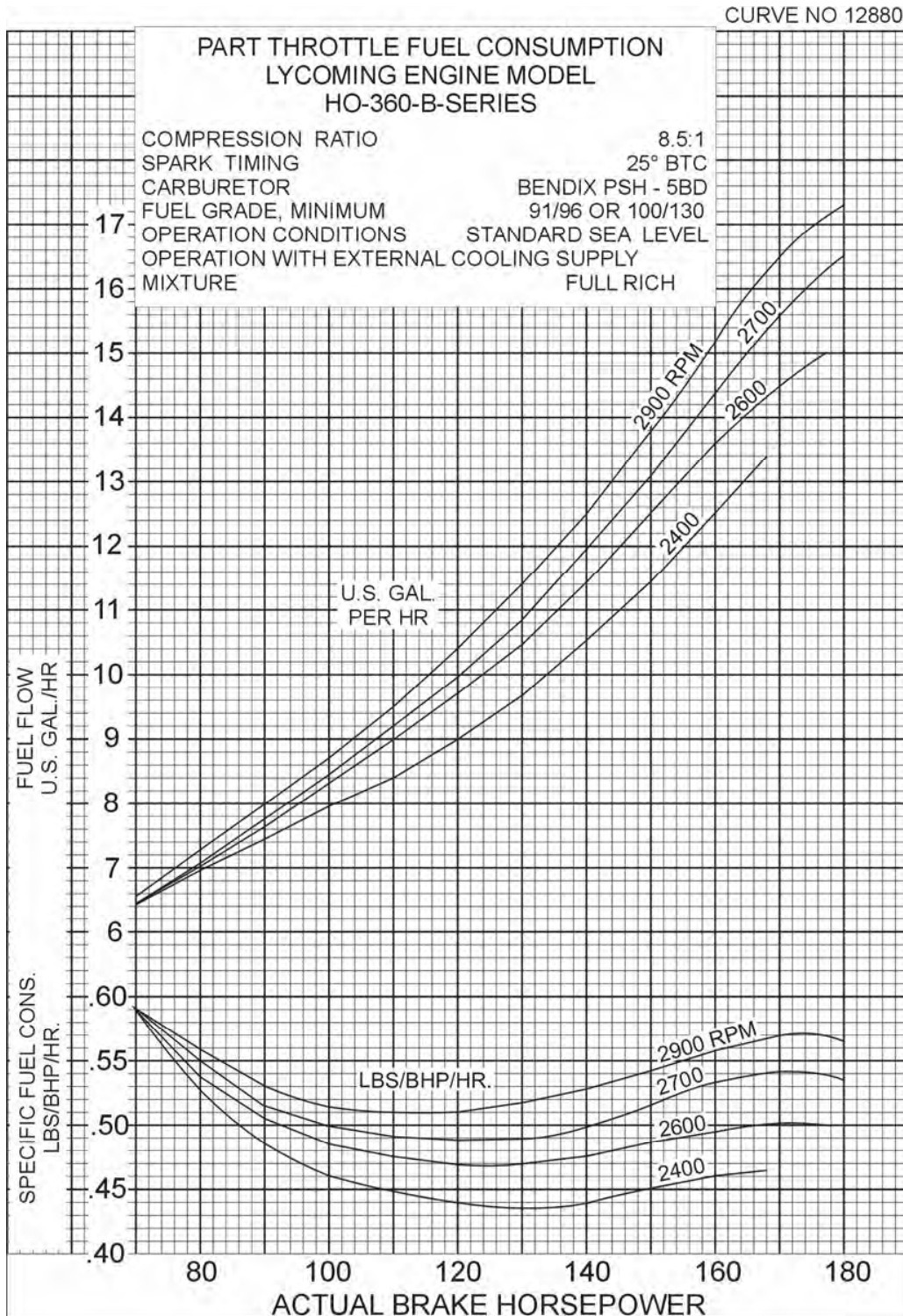

Figure 3-4. Part Throttle Fuel Consumption –
HO-360-B Series

CURVE NO. 12699B

PART THROTTLE FUEL CONSUMPTION
LYCOMING ENGINE MODEL
IO-360-A,-C,-D,-J AND -K SERIES
AIO-360-A SERIES

COMPRESSION RATIO 8.70:1
SPARK TIMING 25° BTC
FUEL INJECTOR, BENDIX RSA-5AD1
FUEL GRADE MINIMUM 100/130
MIXTURE CONTROL- MANUAL TO BEST ECONOMY
OR BEST POWER AS INDICATED

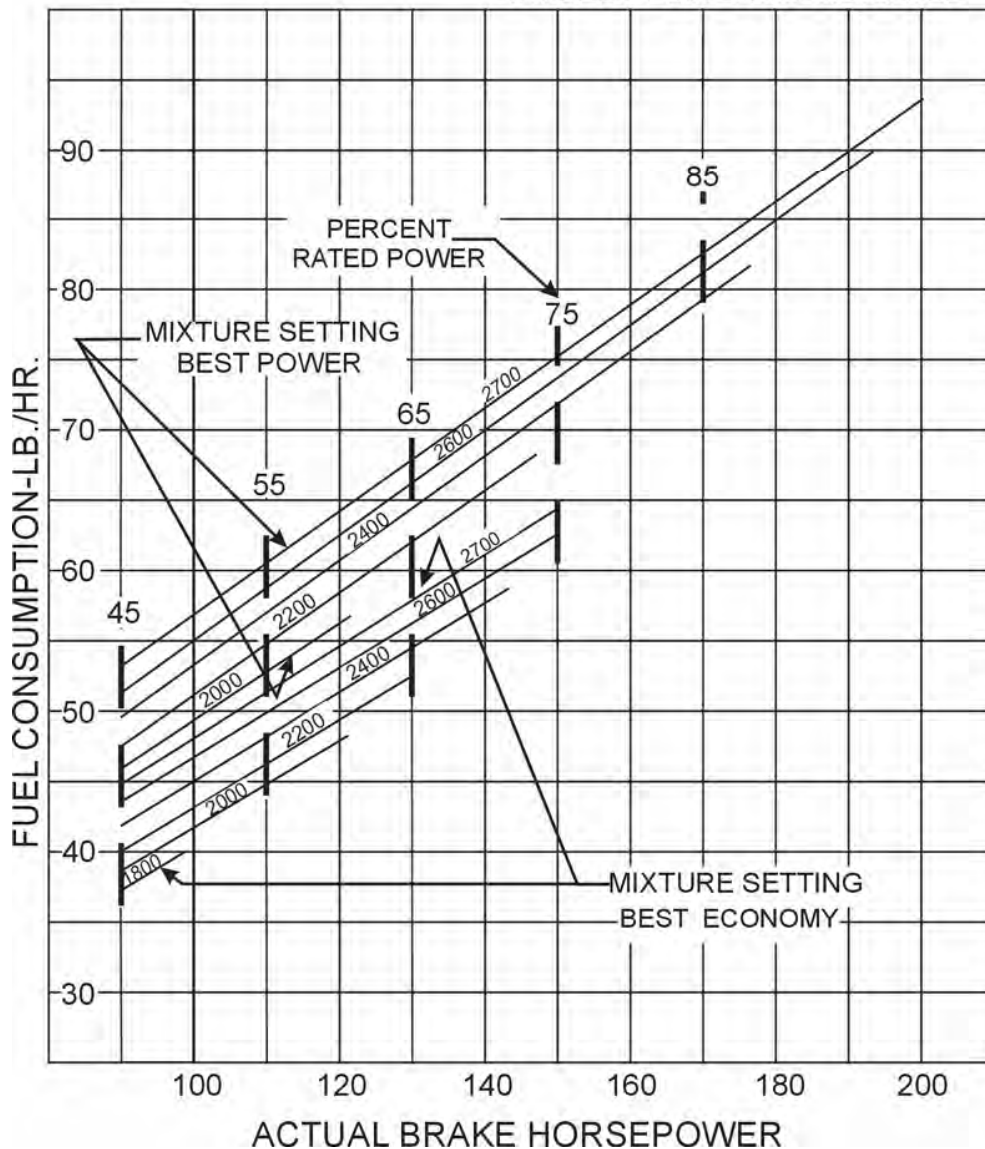

Figure 3-5. Part Throttle Fuel Consumption – IO-360-A, -C, -D, -J, -K; AIO-360 Series

CURVE NO. 12849-A

PART THROTTLE FUEL CONSUMPTION
LYCOMING ENGINE MODEL
IO-360-B,-E,-F AND M1A SERIES

COMPRESSION RATIO
SPARK TIMING
FUEL INJECTOR,
MIXTURE CONTROL-
FUEL GRADE MINIMUM

8.50:1
25° BTC
PAC TYPE RSA-5AD1
MANUAL TO BEST ECONOMY
OR BEST POWER AS INDICATED
91/96

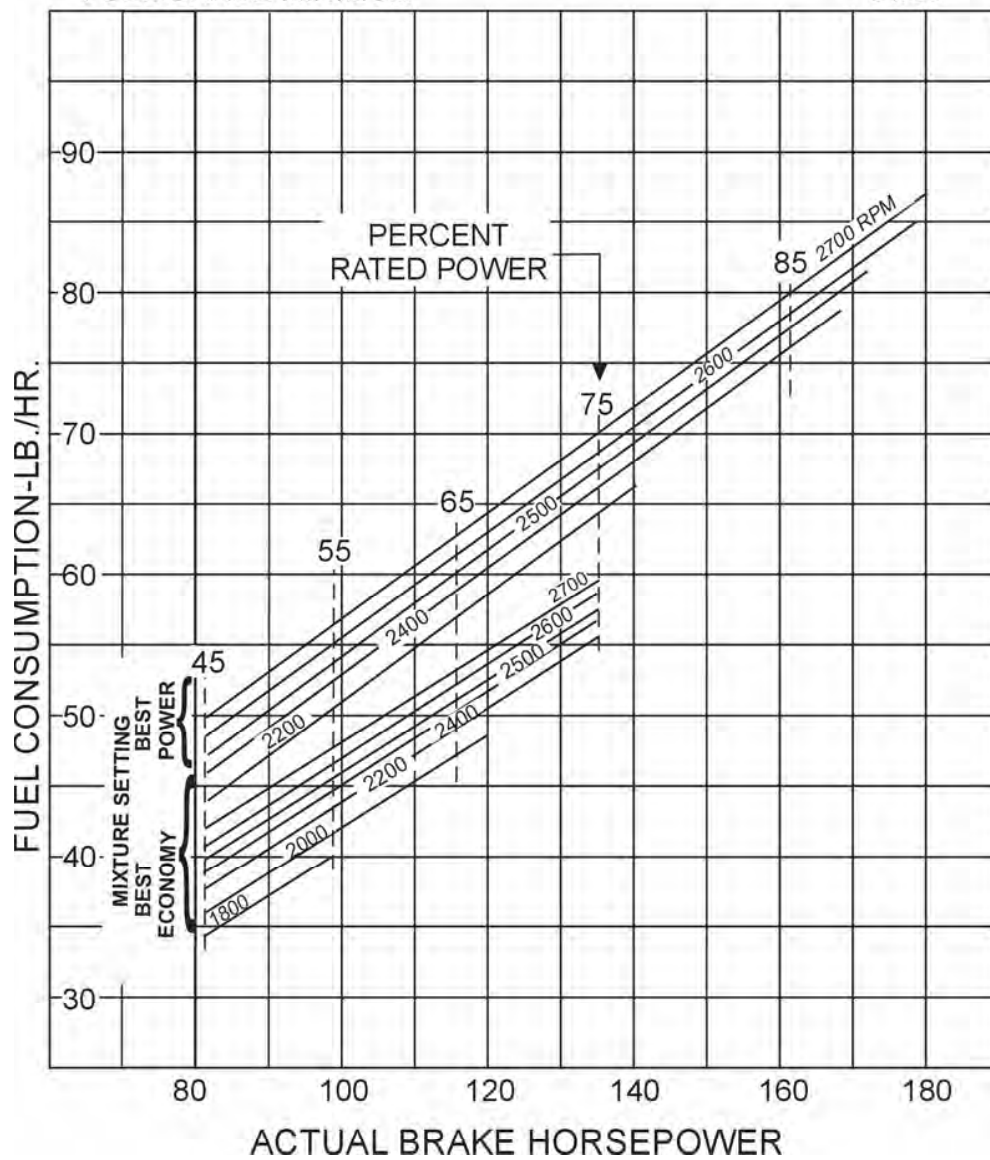

Figure 3-6. Part Throttle Fuel Consumption –
IO-360-B, -E, -F, ♦, -M1B Series (Excepting IO-360-B1A, -B1C); HIO-360-G1A

♦ - For information pertaining to engine model (L)IO-360-M1A, refer to Operation and Installation Manual P/N 60297-36.

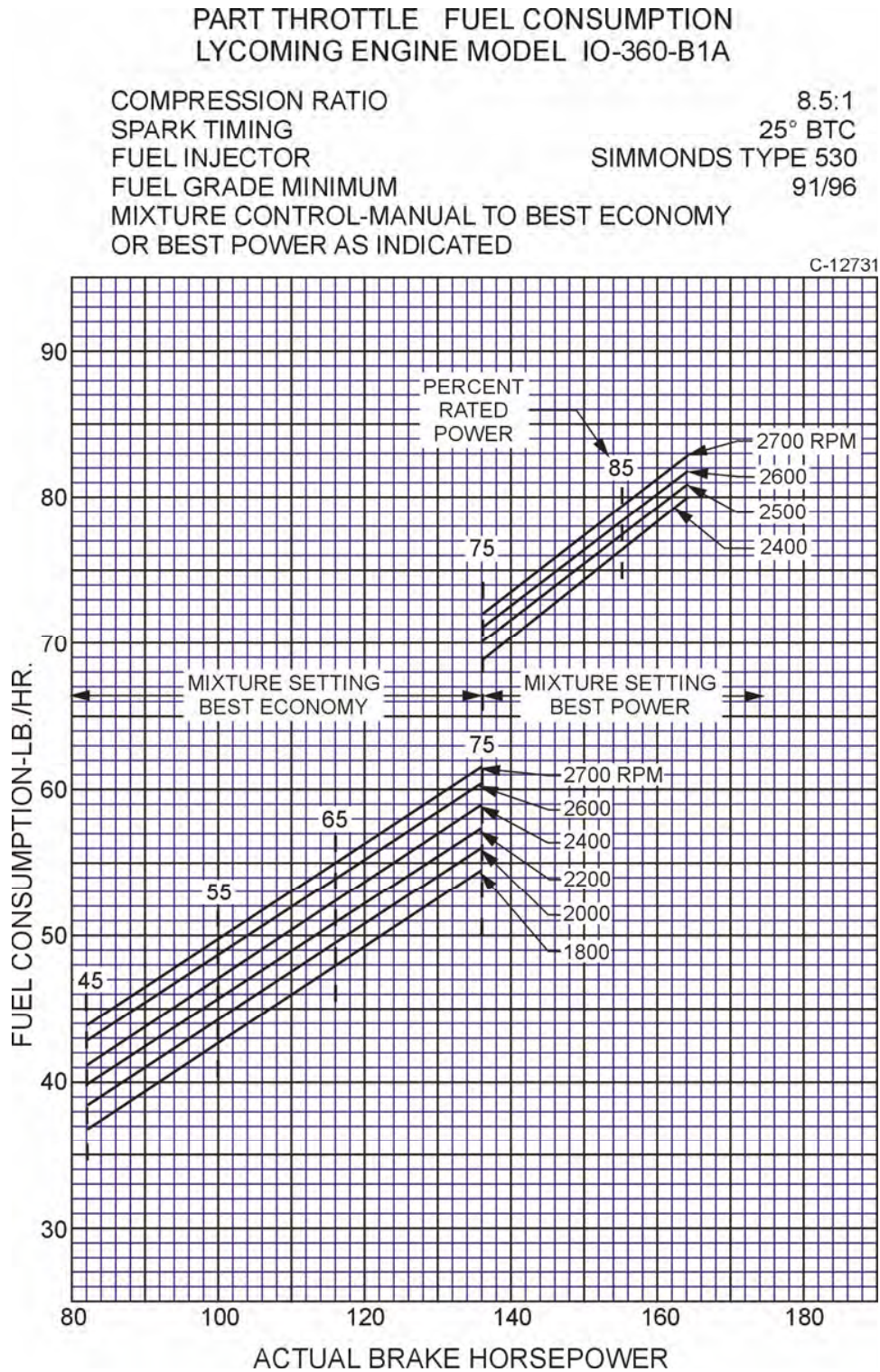

Figure 3-7. Part Throttle Fuel Consumption –
IO-360-B1A

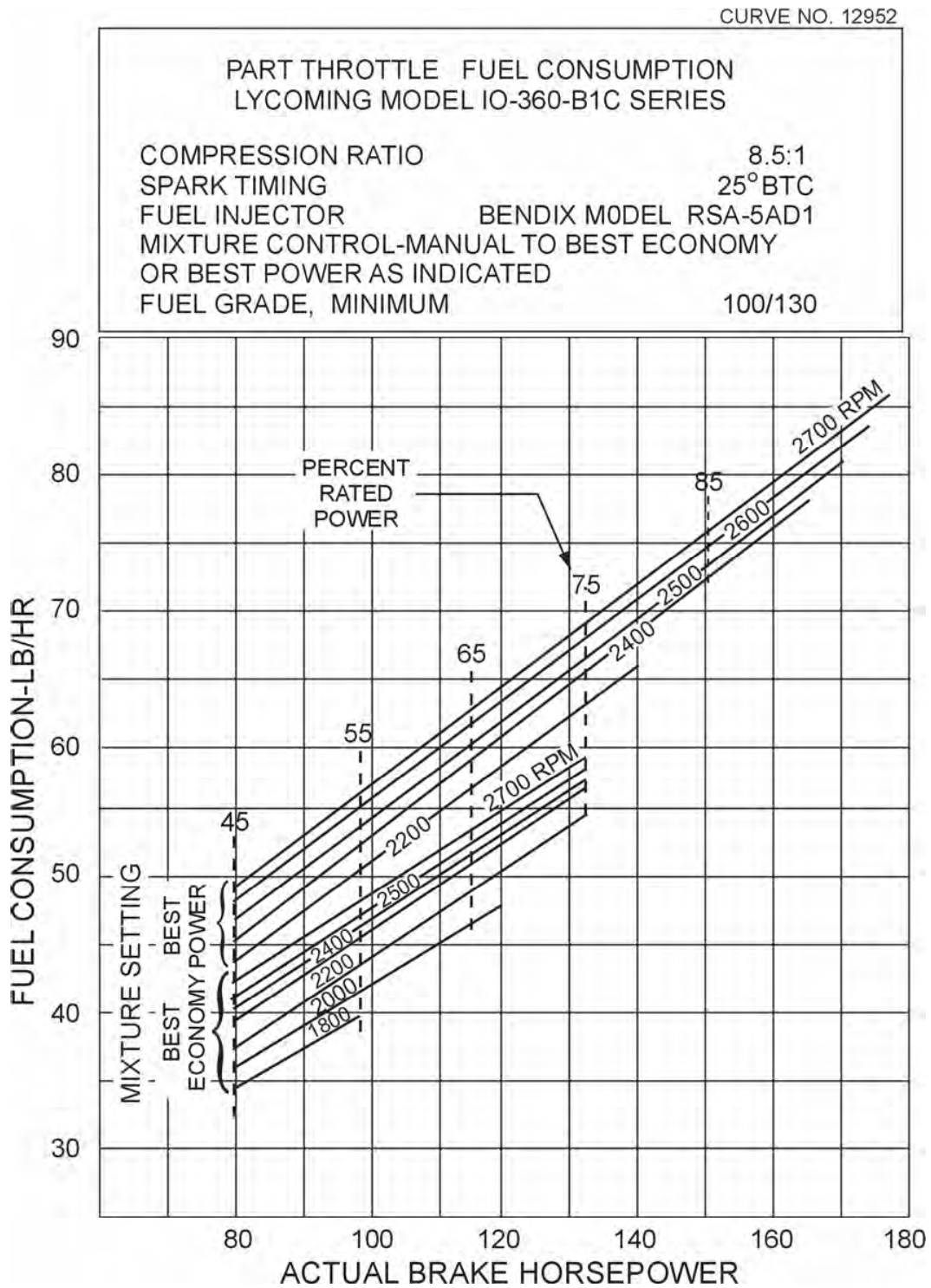

Figure 3-8. Part Throttle Fuel Consumption – IO-360-B1C

CURVE NO13518

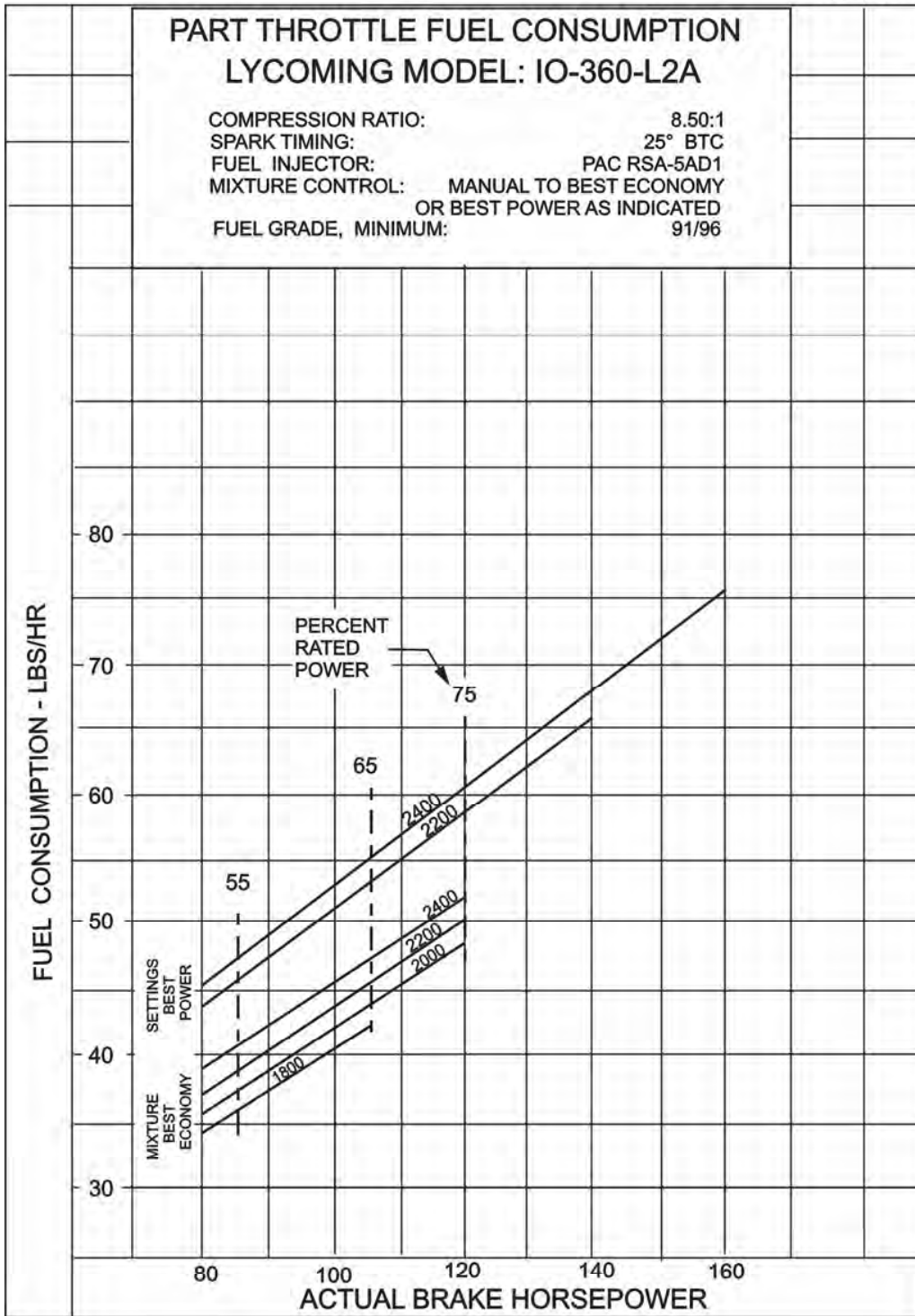

Figure 3-9. Part Throttle Fuel Consumption – IO-360-L2A

FUEL FLOW vs PERCENT RATED POWER
LYCOMING MODEL TIO-360-A SERIES

COMPRESSION RATIO	7.30:1
SPARK ADVANCE	25° BTC
FUEL INJECTOR	BENDIX RSA-5AD1
TURBOCHARGER	AIRESEARCH TE04
MIXTURE CONTROL-MANUAL TO FLOWMETER GAGE	
FUEL GRADE, MINIMUM	100/130

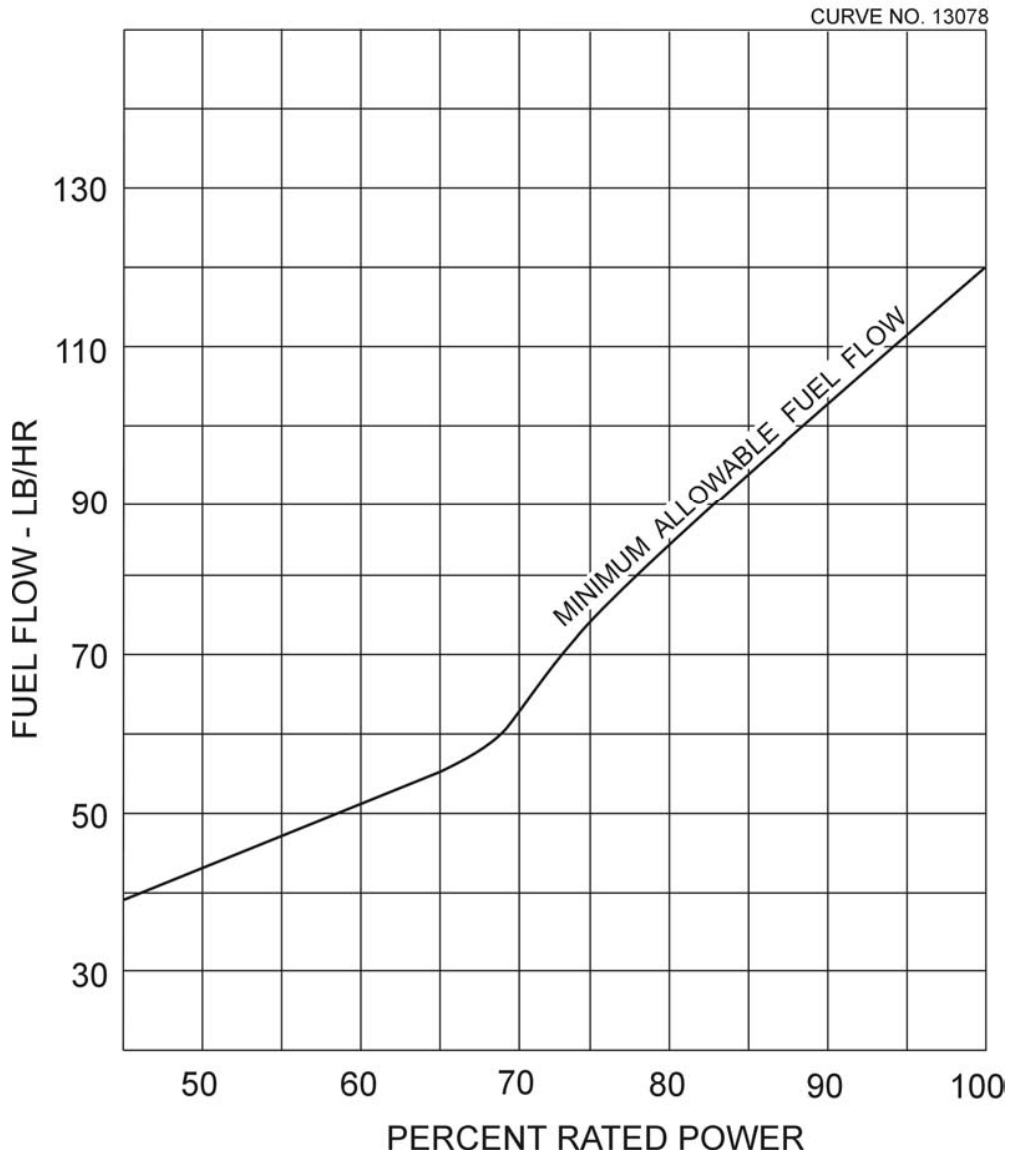

Figure 3-10. Fuel Flow vs Percent Rated Power –
TIO-360-A Series

FUEL FLOW vs PERCENT RATED POWER

LYCOMING ENGINE SPEED 3200 RPM
MANUAL MIXTURE CONTROL TO FLOW METER GAGE

HIO-360-D SERIES

CURVE NO. 13063-A

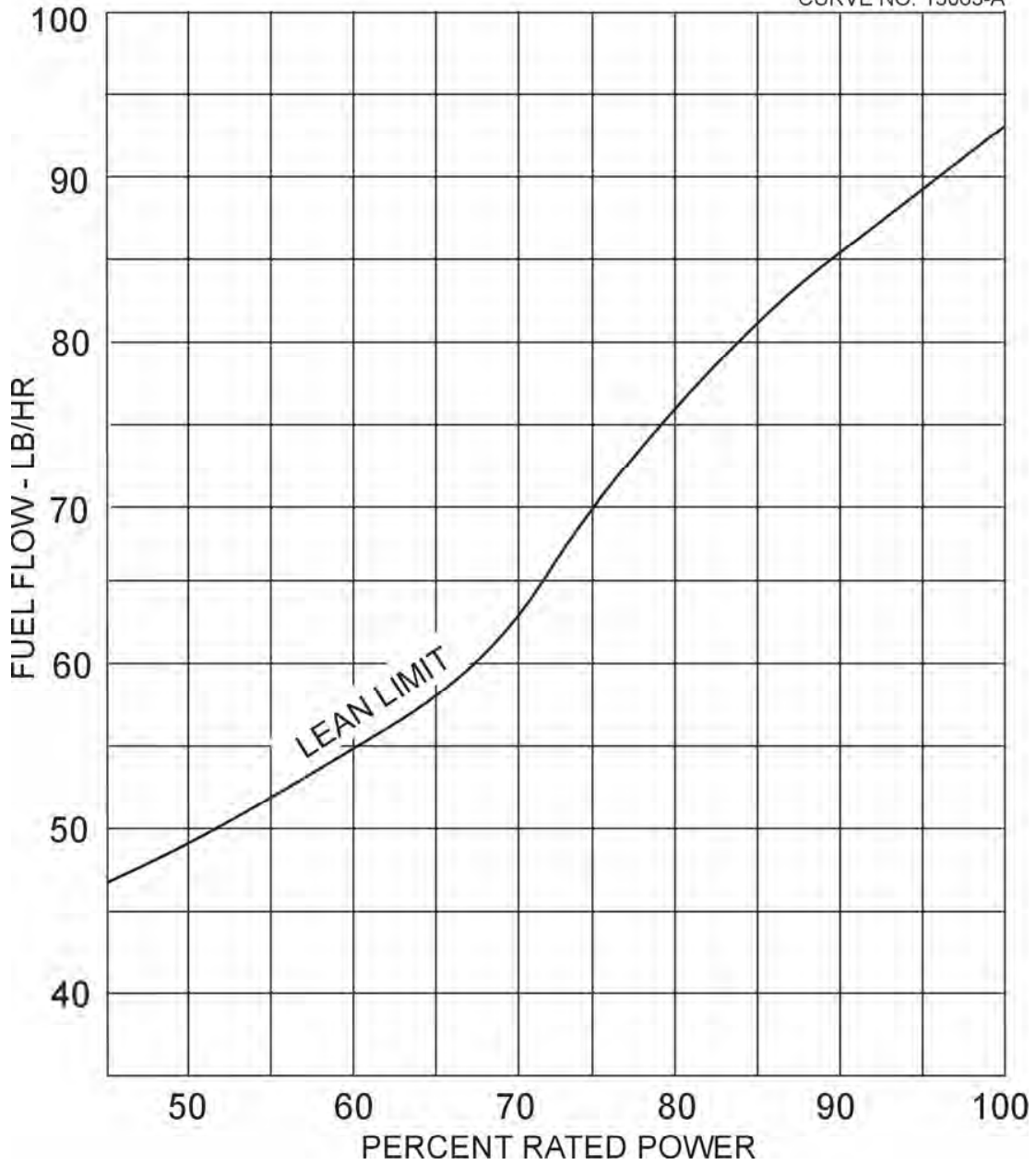

Figure 3-11. Fuel Flow vs Percent Rated Power –
HIO-360-D

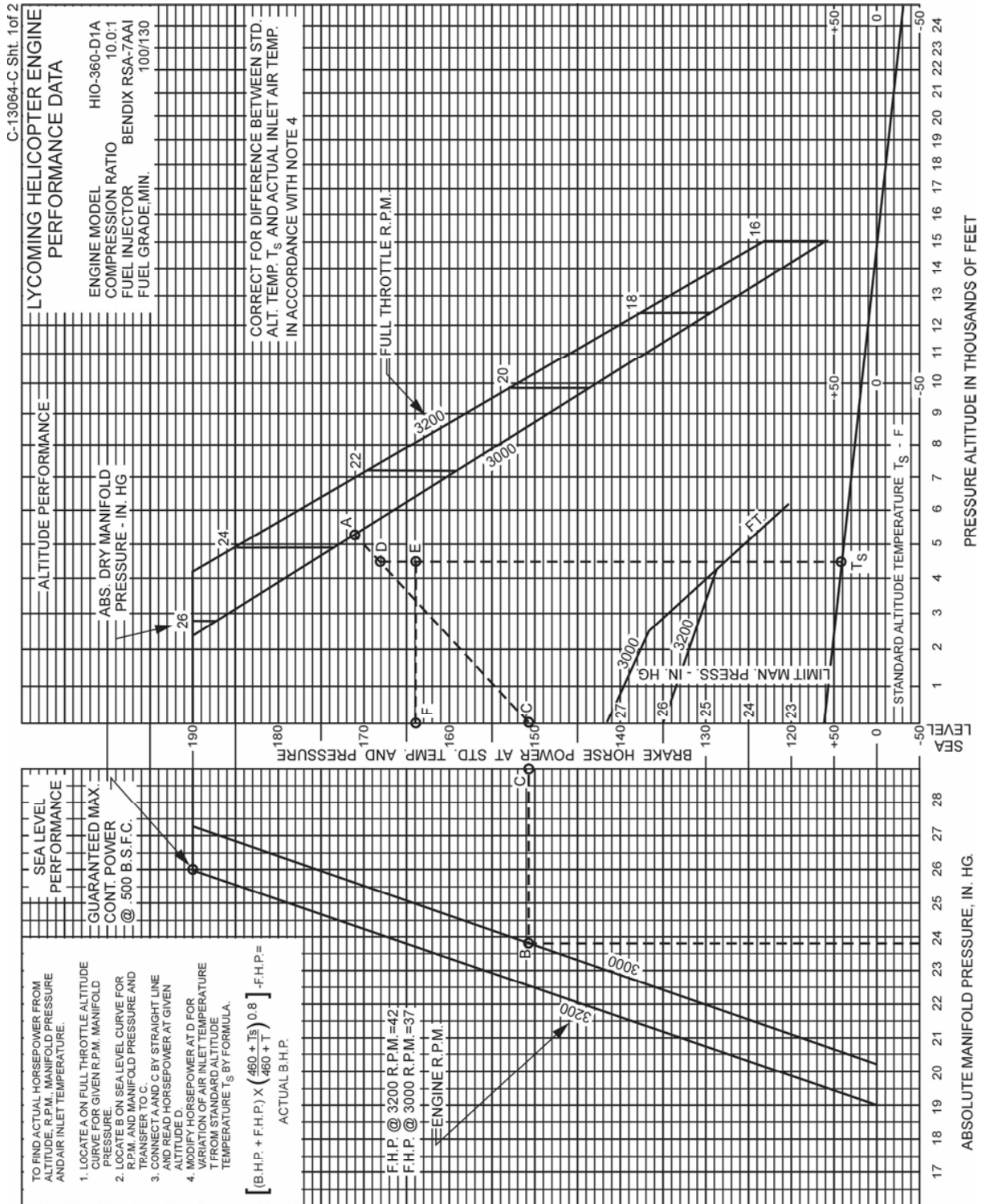

Figure 3-12. Sea Level and Altitude Performance – HIO-360-D (Sheet 1 of 2)

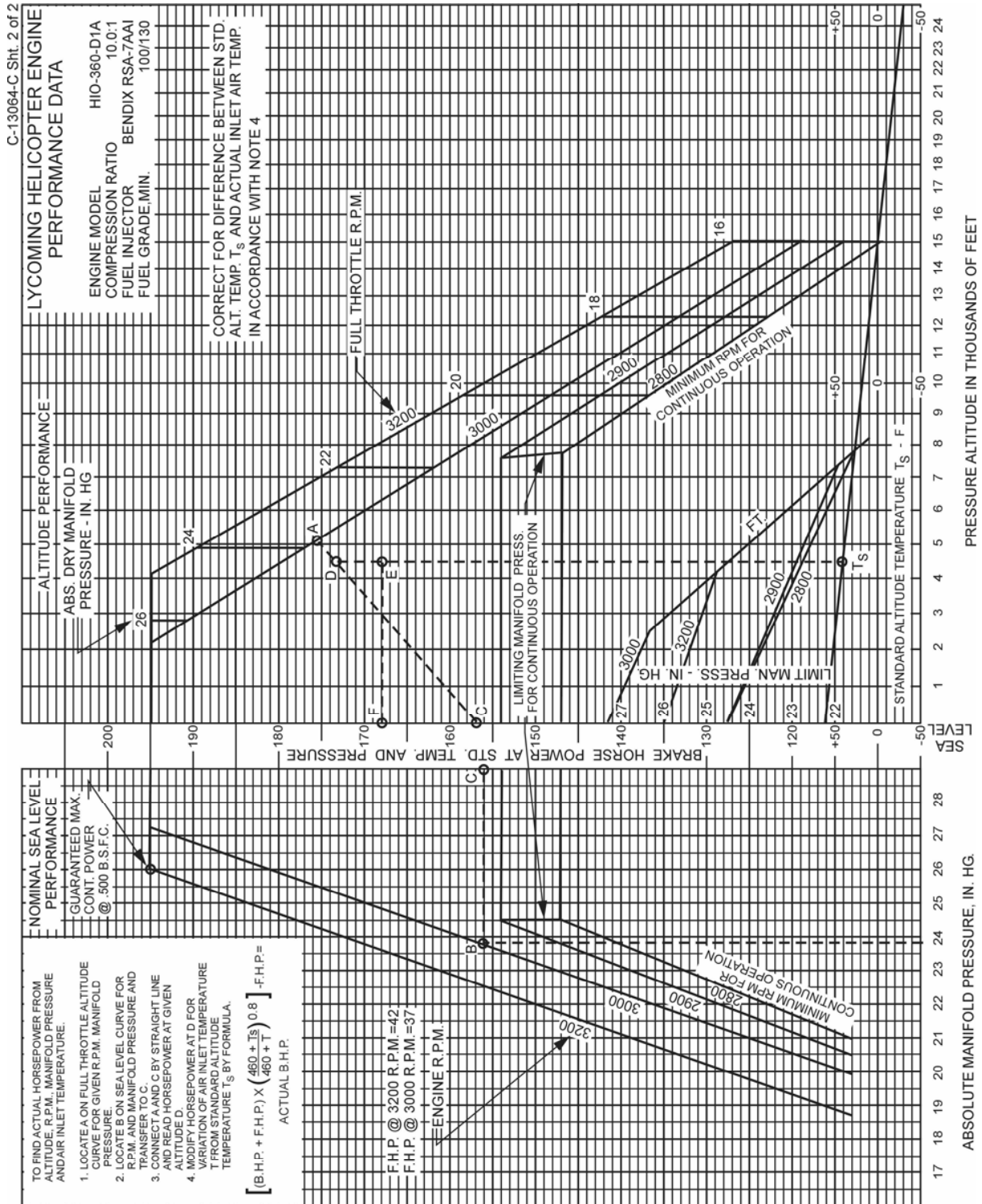

Figure 3-13. Sea Level and Altitude Performance – HIO-360-D (Sheet 2 of 2)

FUEL FLOW vs PERCENT RATED POWER
LYCOMING ENGINE MODEL
HIO-360-A SERIES

FUEL INJECTOR BENDIX RSA-5AB1
ENGINE SPEED 2900 RPM
MANUAL MIXTURE CONTROL TO FLOWMETER GAGE

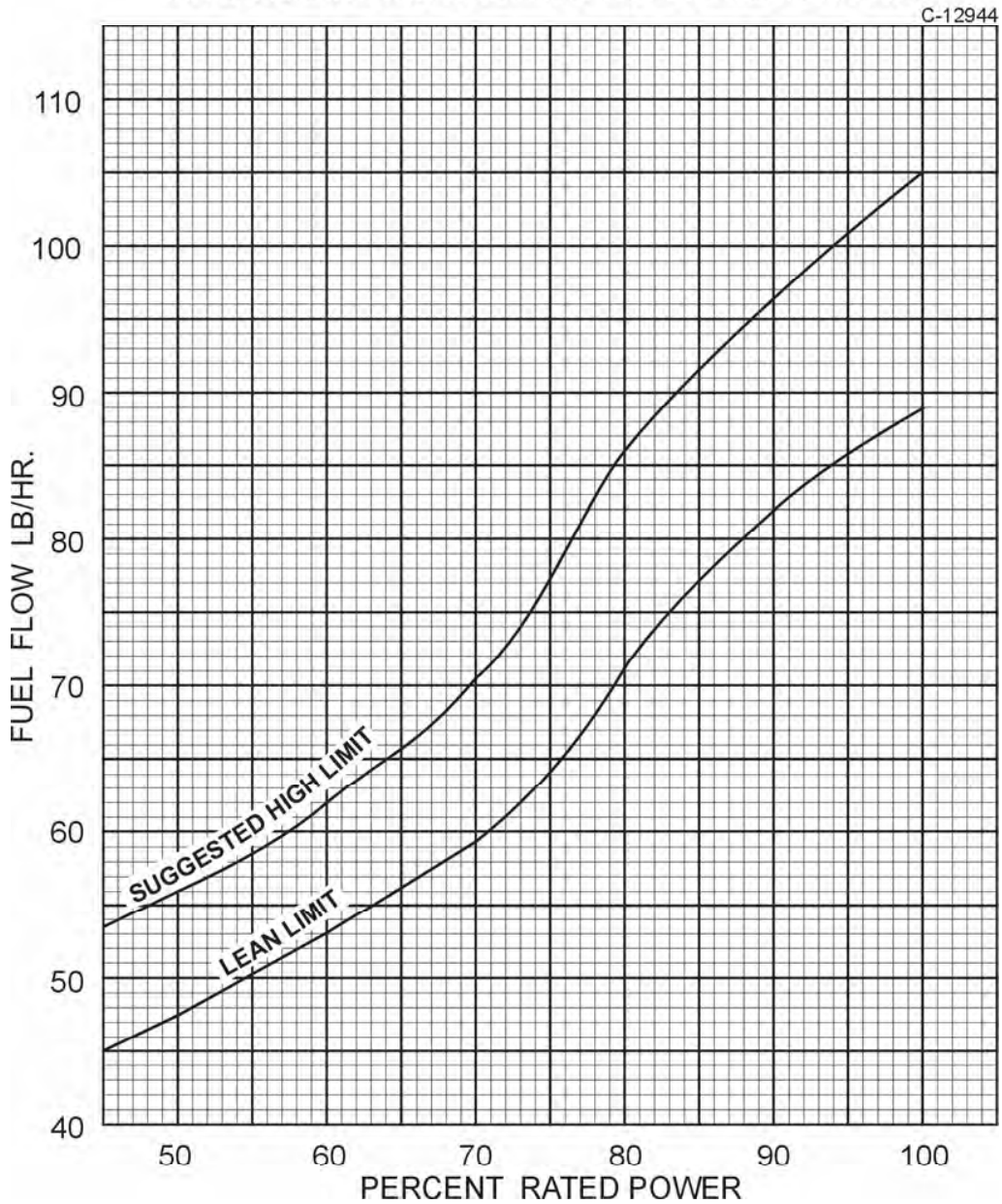

Figure 3-14. Fuel Flow vs Percent Rated Power –
HIO-360-A Series

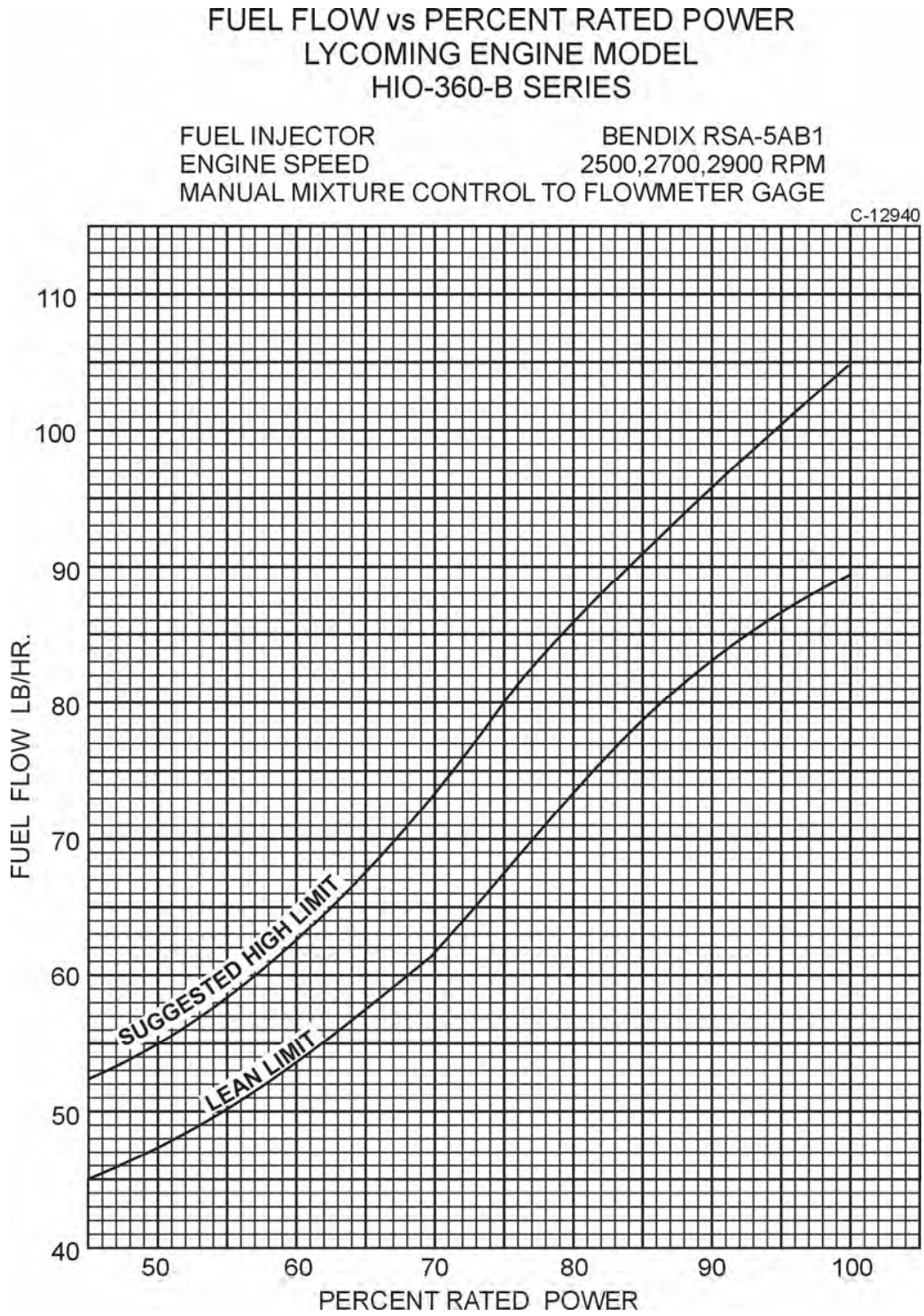

Figure 3-15. Fuel Flow vs Percent Rated Power –
HIO-360-B Series

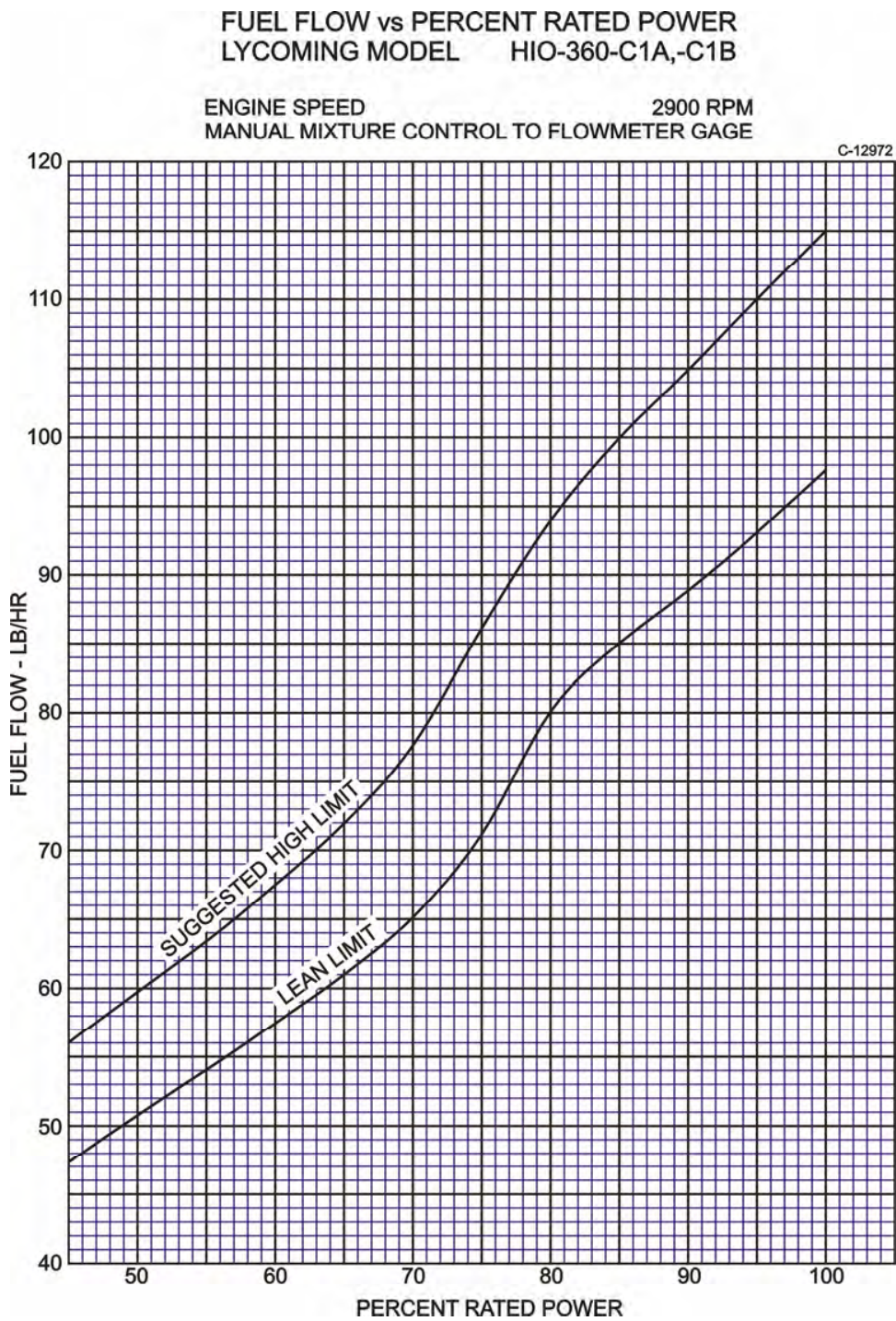

Figure 3-16. Fuel Flow vs Percent Rated Power –
HIO-360-C Series

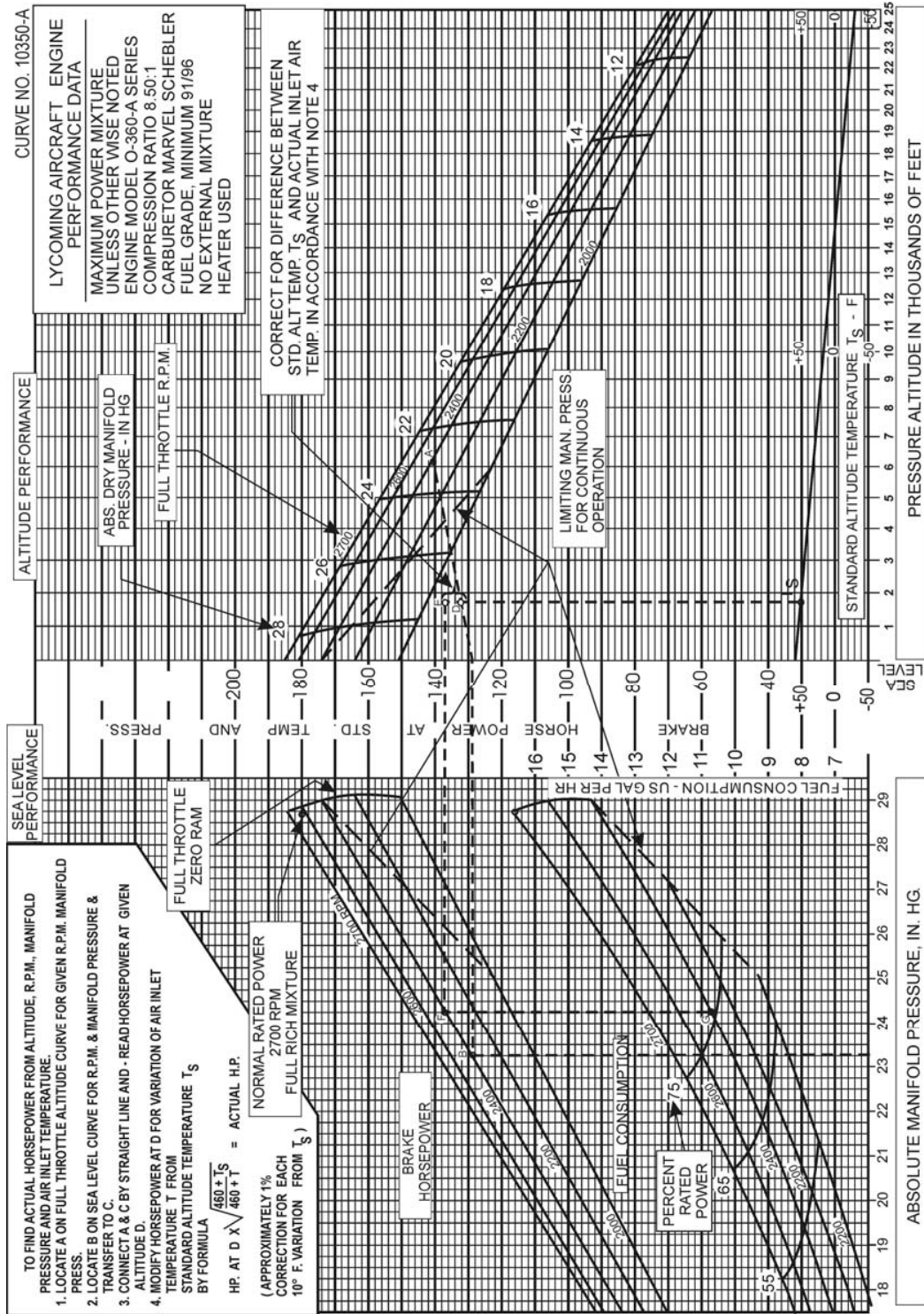

Figure 3-17. Sea Level and Altitude Performance – O-360-A, -C (Except those listed for Figure 3-40); HIO-360-A Series

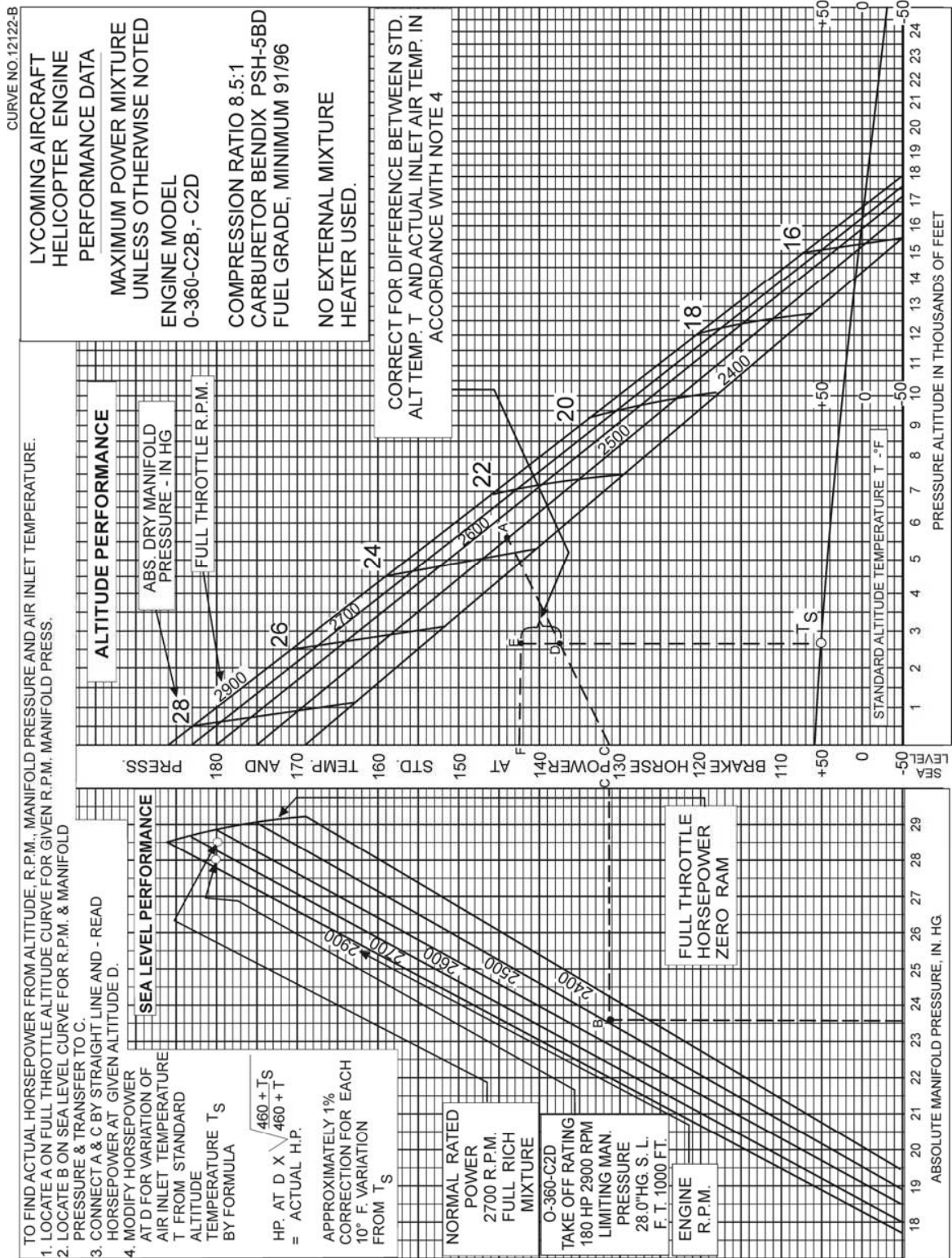

Figure 3-18. Sea Level and Altitude Performance – O-360-C2B, -C2D

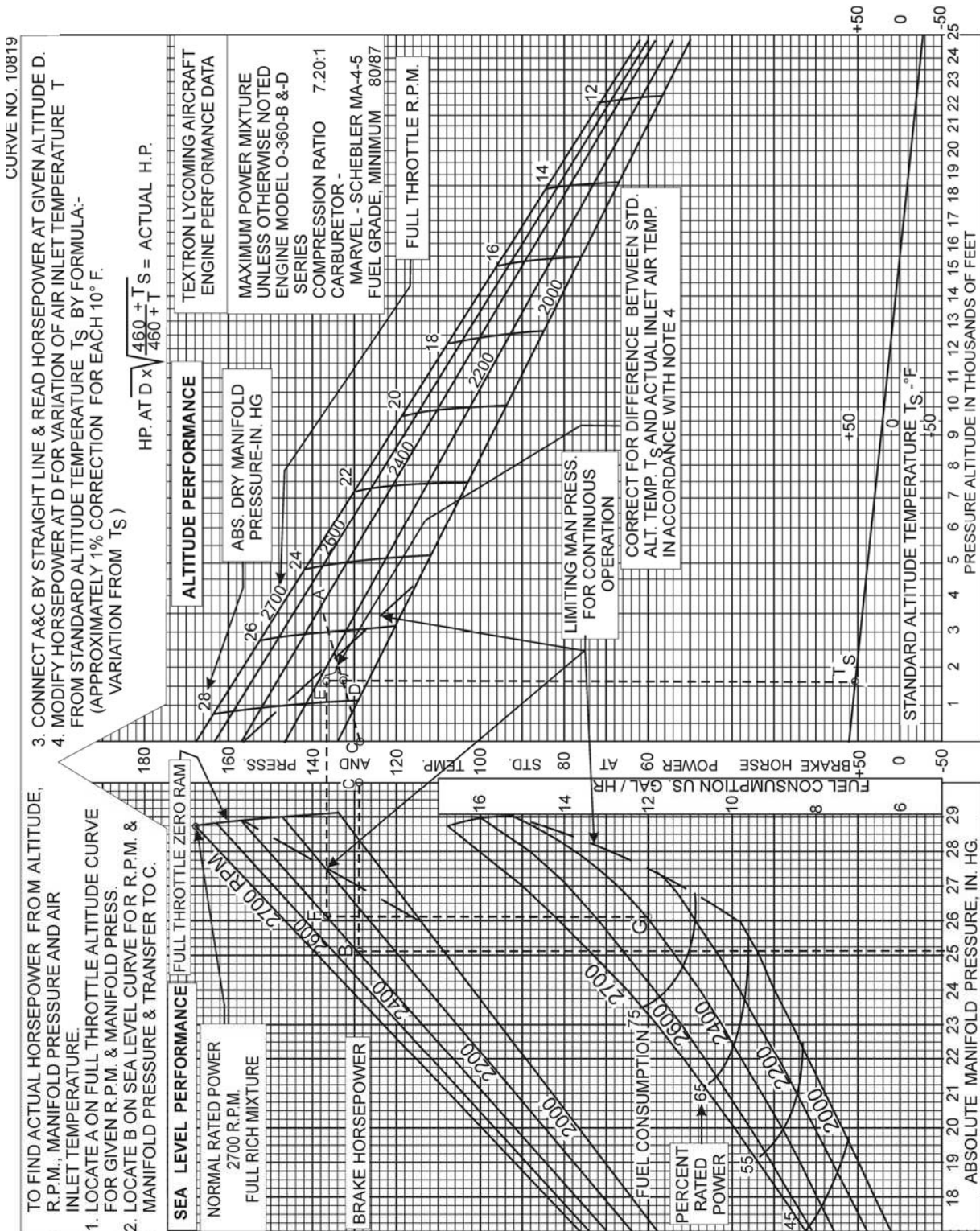

Figure 3-19. Sea Level and Altitude Performance –
O-360-B, -D Series

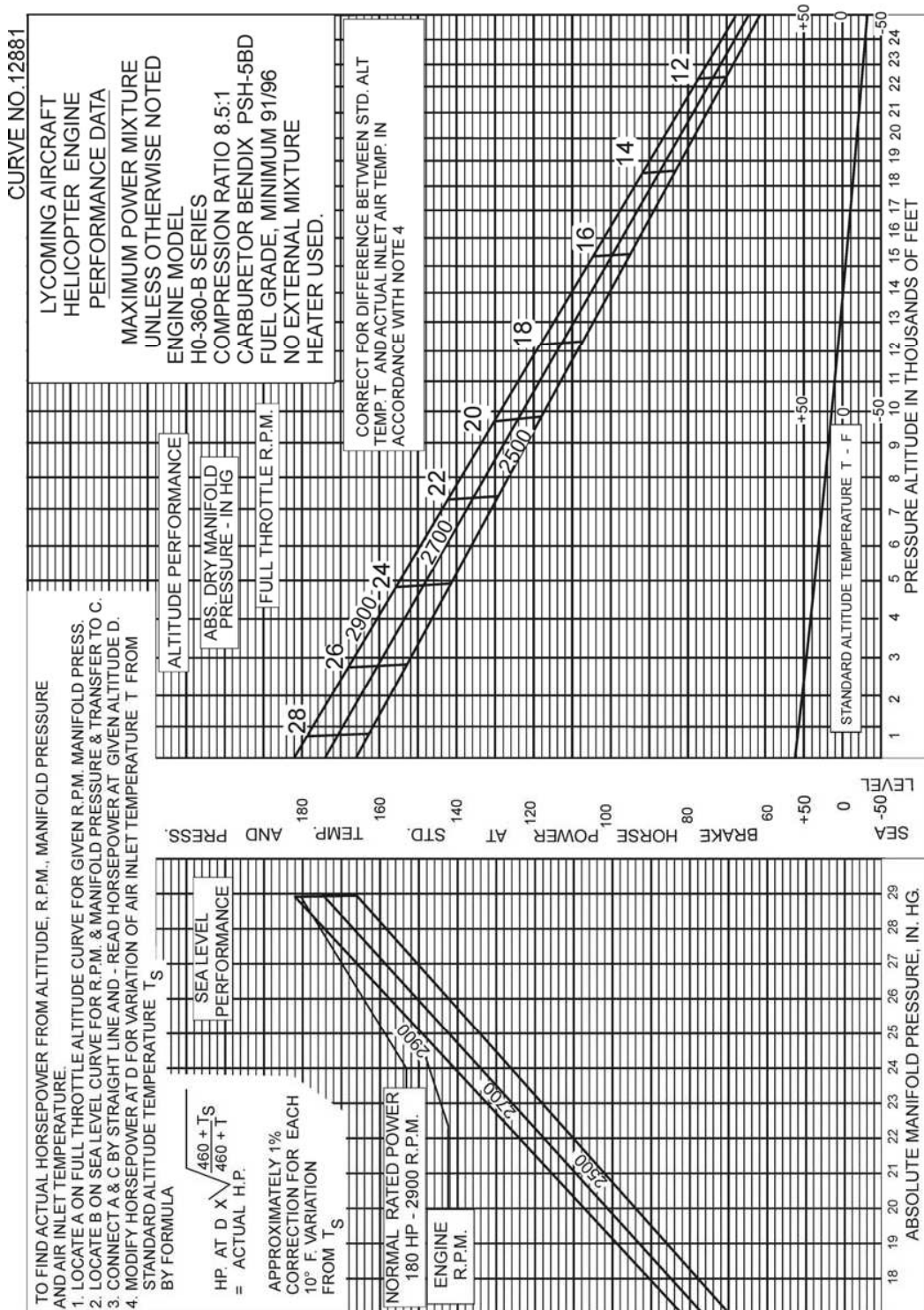

Figure 3-20. Sea Level and Altitude Performance –
HO-360-B Series

**SECTION 3
OPERATING INSTRUCTIONS**

**LYCOMING OPERATOR'S MANUAL
O-360 AND ASSOCIATED MODELS**

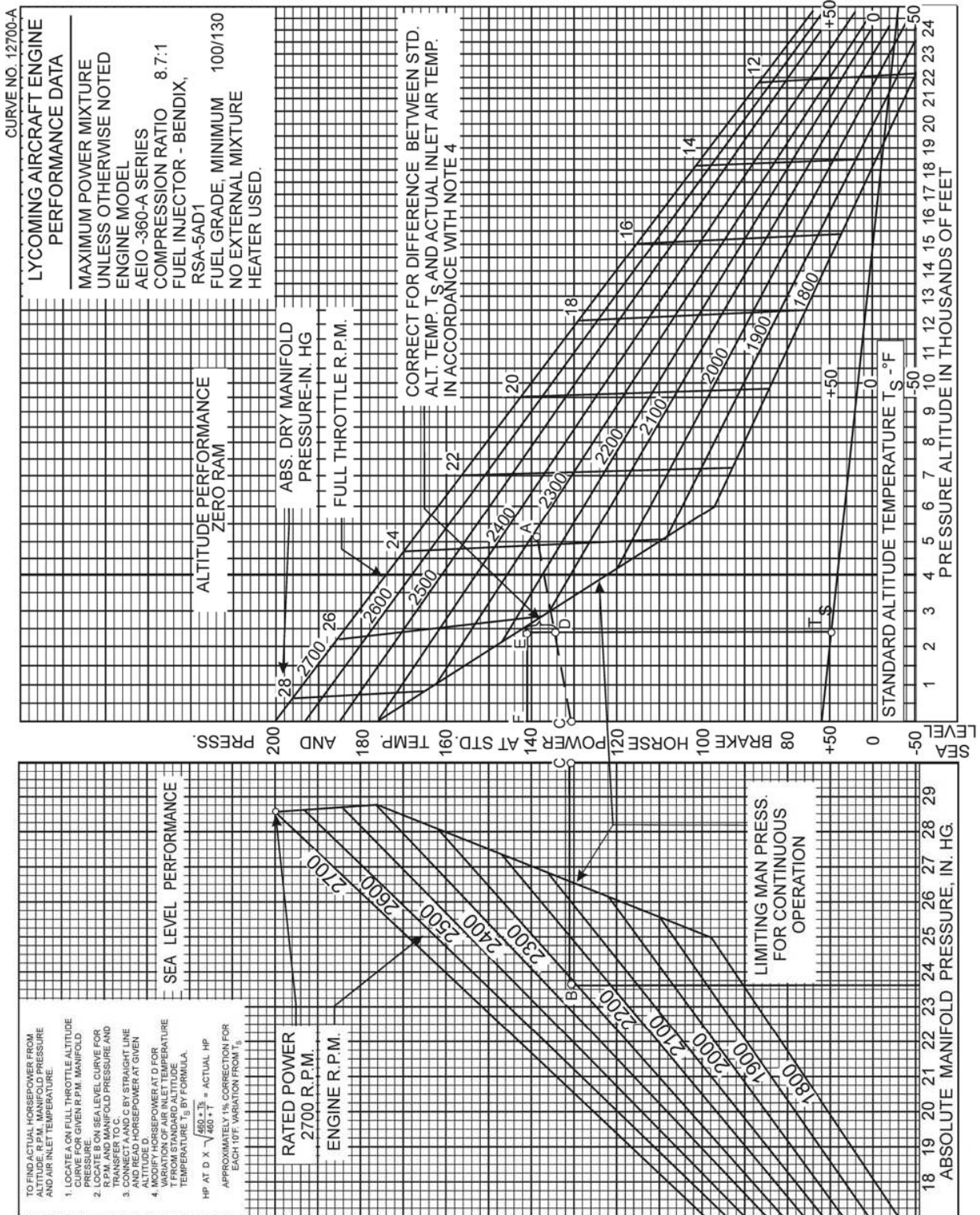

Figure 3-21. Sea Level and Altitude Performance – IO-360-A, -C, -D, -J, -K; AIO-360 Series

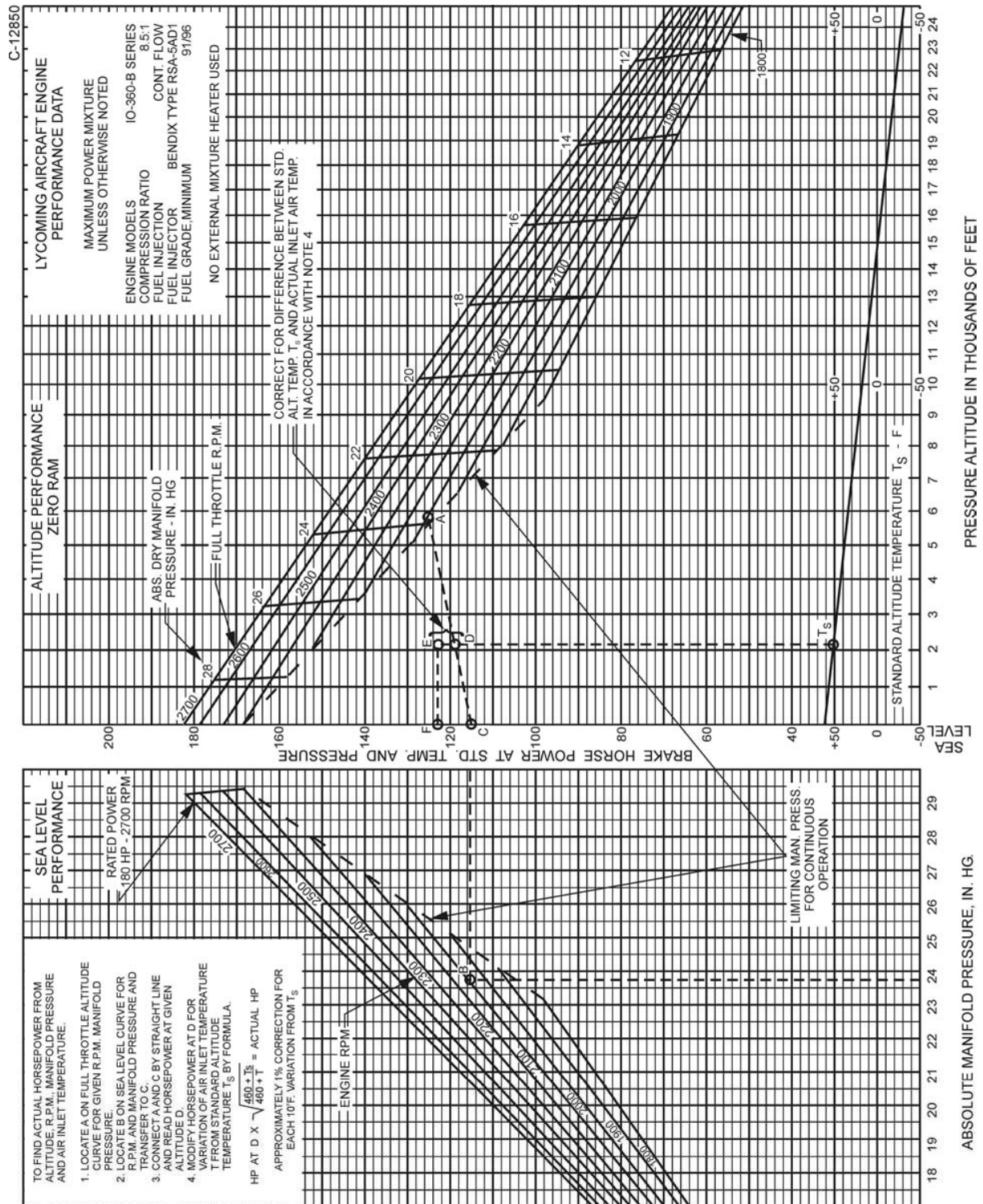

Figure 3-22. Sea Level and Altitude Performance – IO-360-B, -E, -F Series (Excepting IO-360-B1A, -B1C) HIO-360-G1A

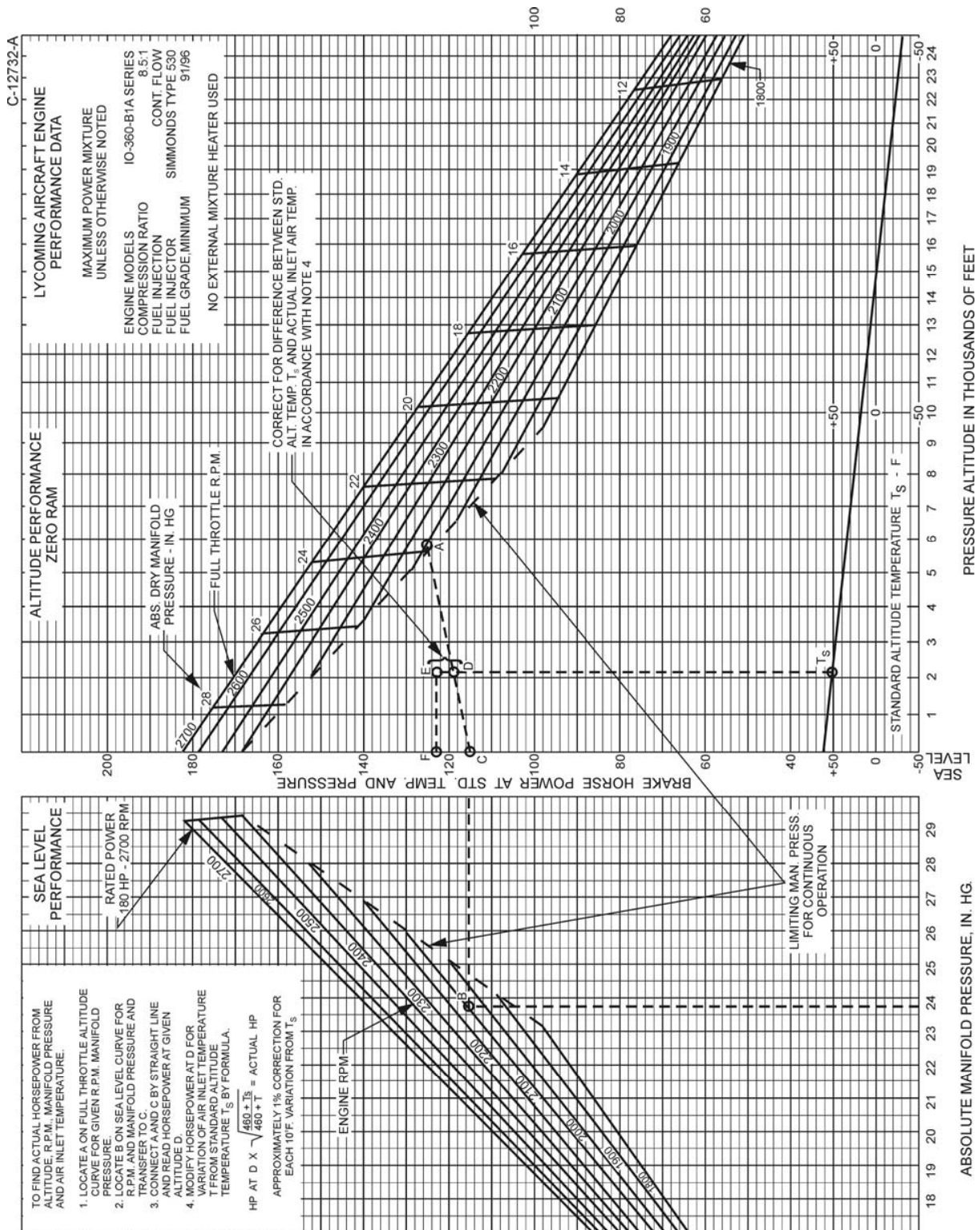

Figure 3-23. Sea Level and Altitude Performance – IO-360-B1A

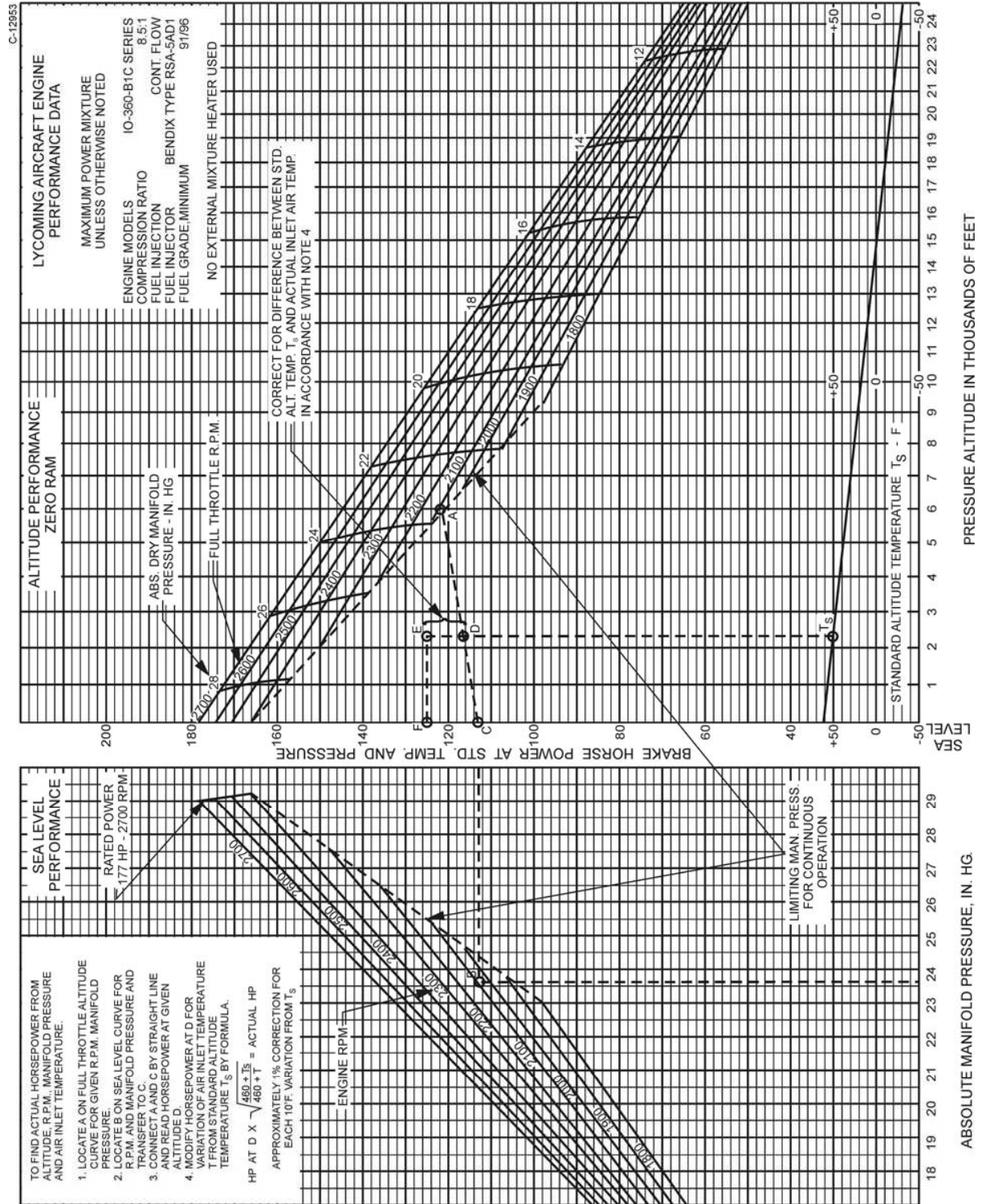

Figure 3-24. Sea Level and Altitude Performance – IO-360-B1C

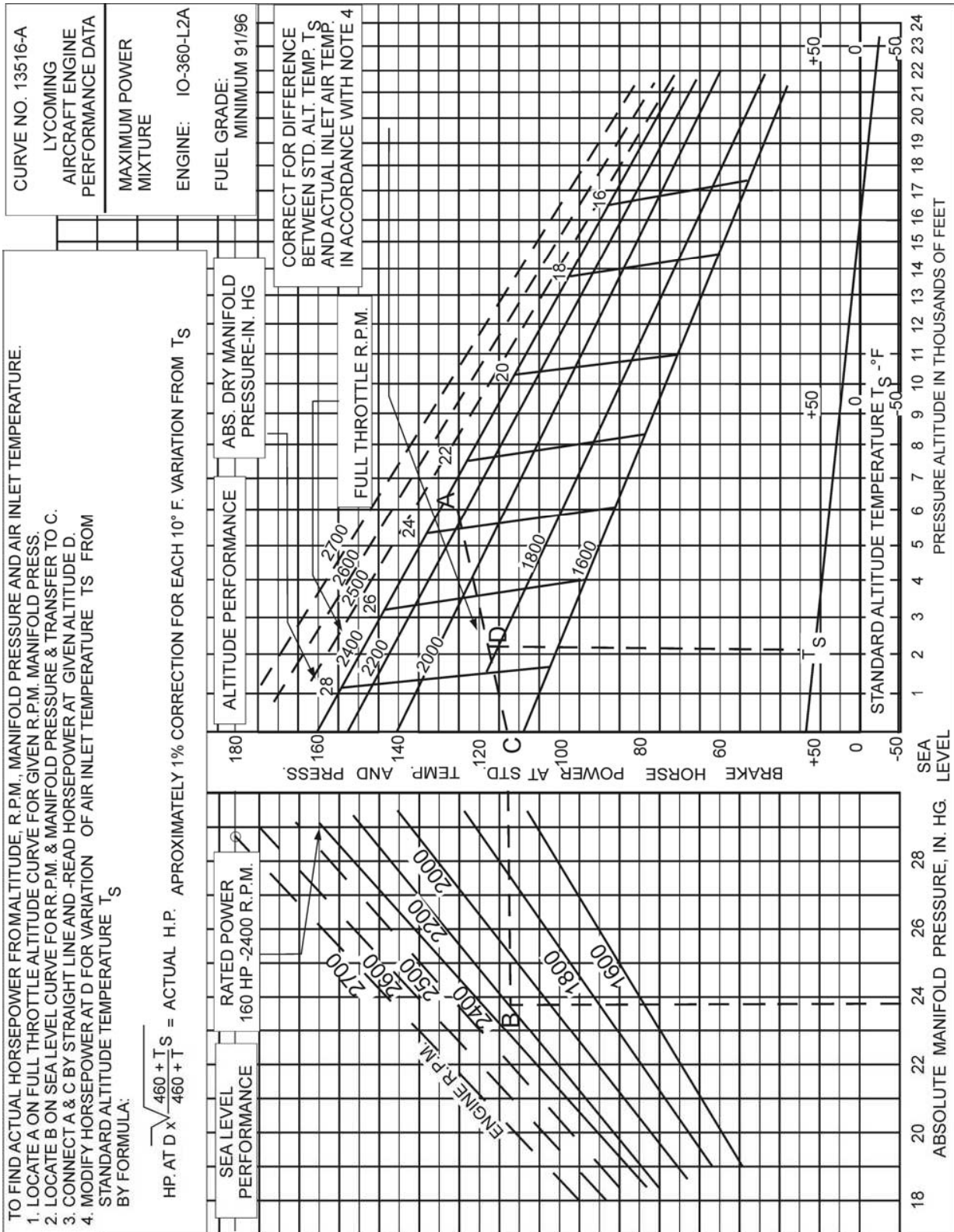

Figure 3-25. Sea Level and Altitude Performance – IO-360-L2A

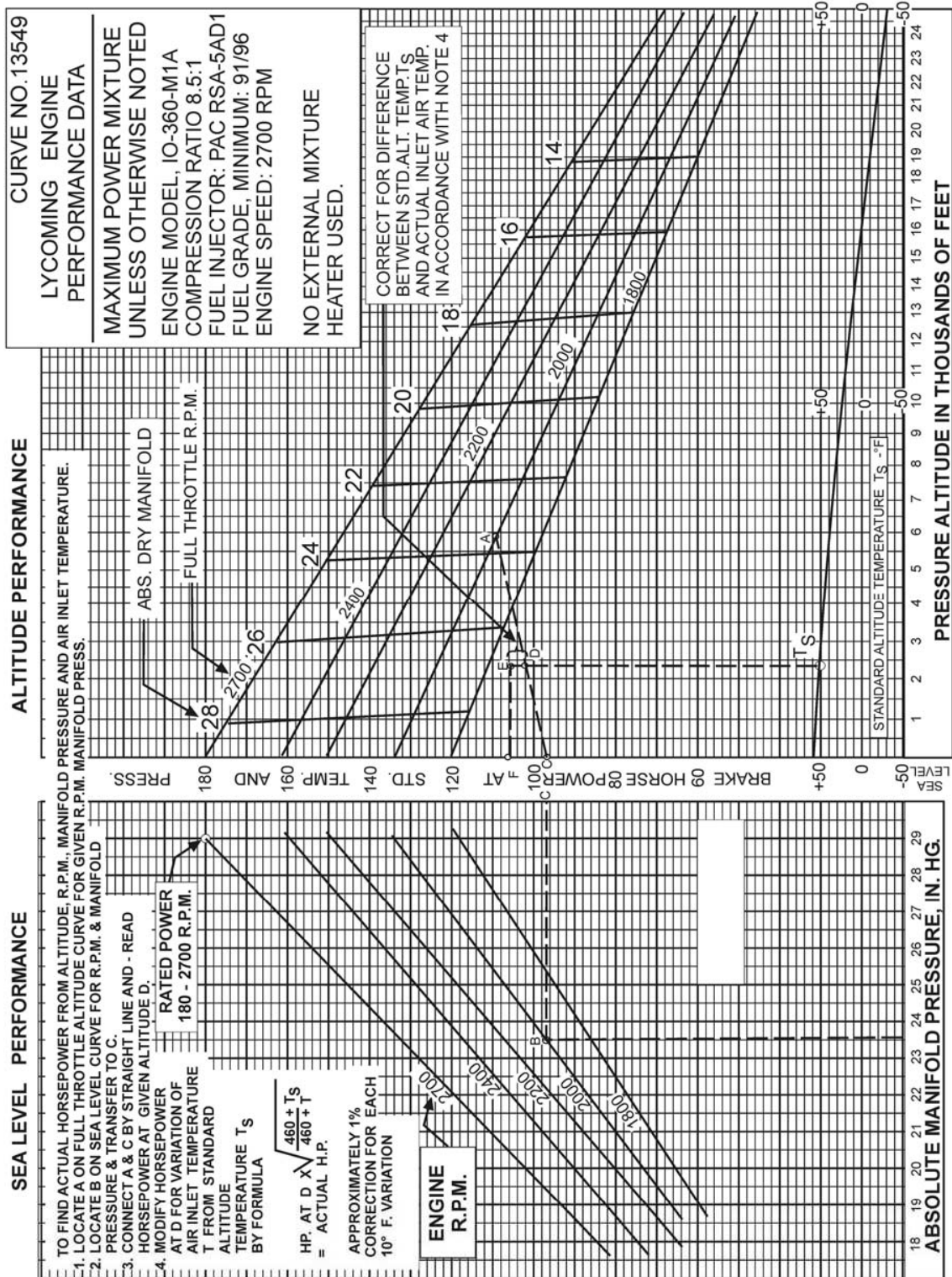

Figure 3-26. Sea Level and Altitude Performance –
IO-360-♦, -M1B

♦ - For information pertaining to engine model (L)IO-360-M1A, refer to Operation and Installation Manual P/N 60297-36.

SECTION 3
OPERATING INSTRUCTIONS

LYCOMING OPERATOR'S MANUAL
O-360 AND ASSOCIATED MODELS

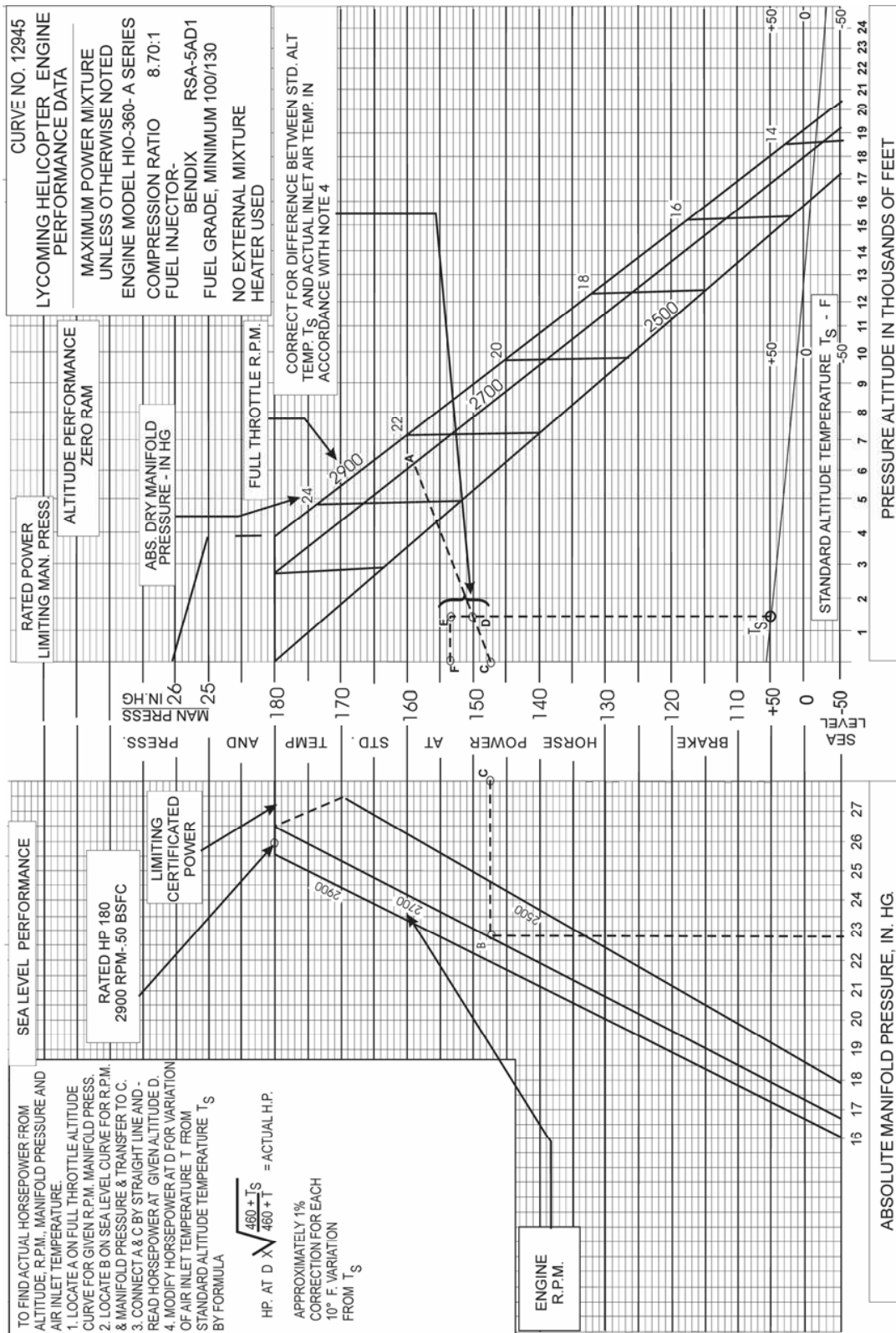

Figure 3-28. Sea Level and Altitude Performance –
HIO-360-A Series

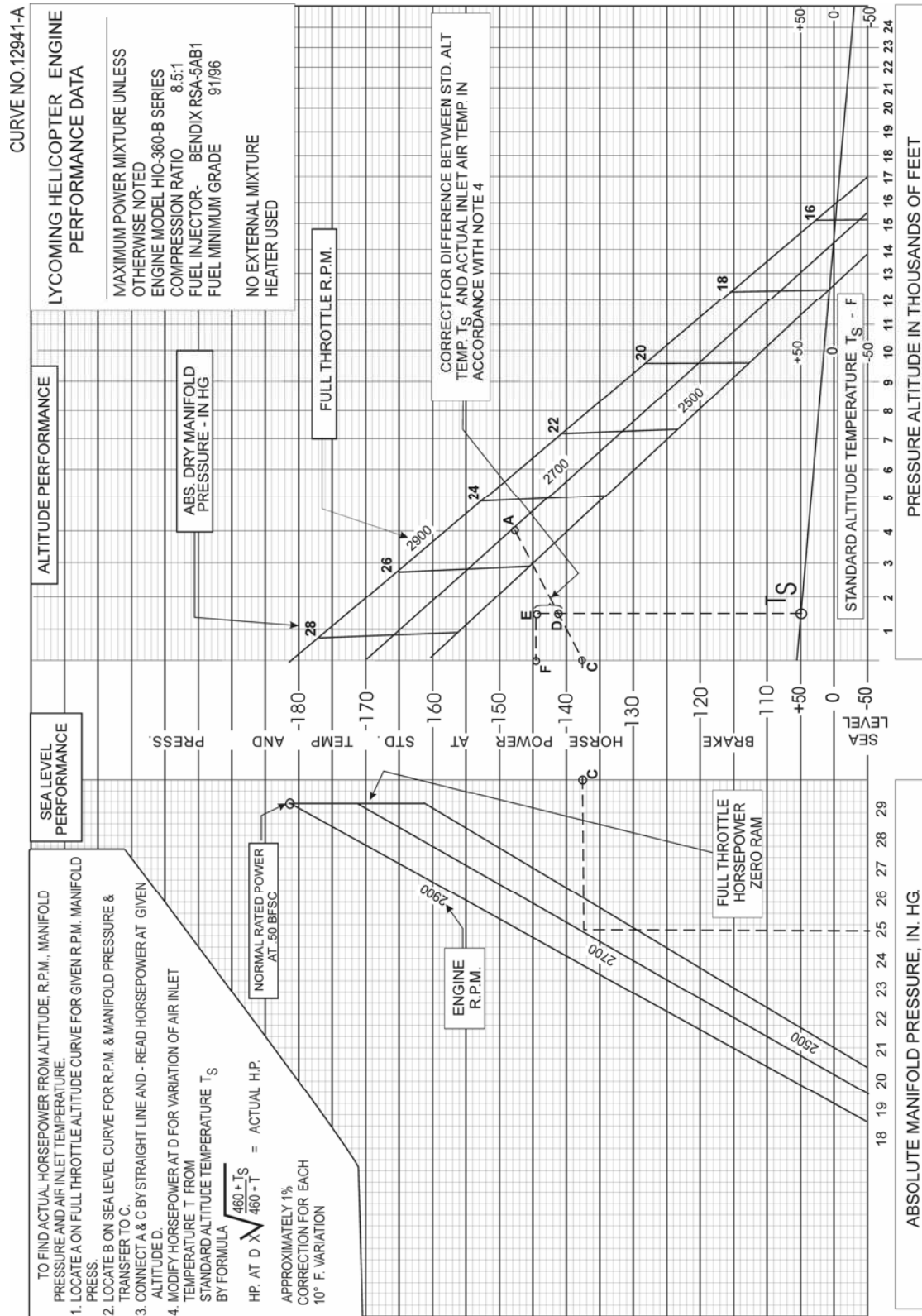

Figure 3-29. Sea Level and Altitude Performance – HIO-360-B Series

**SECTION 3
OPERATING INSTRUCTIONS**

**LYCOMING OPERATOR'S MANUAL
O-360 AND ASSOCIATED MODELS**

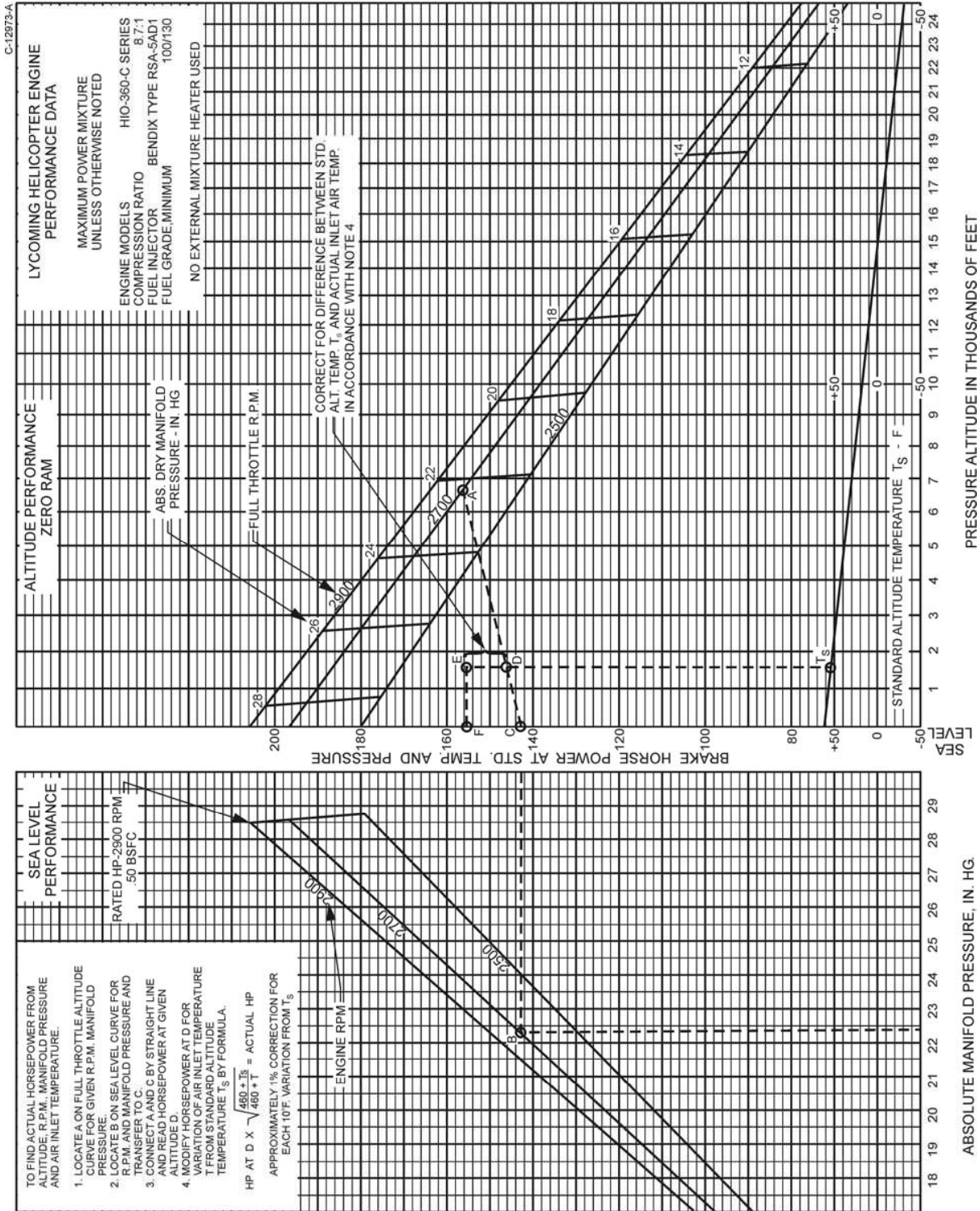

Figure 3-30. Sea Level and Altitude Performance –
H10-360-C Series

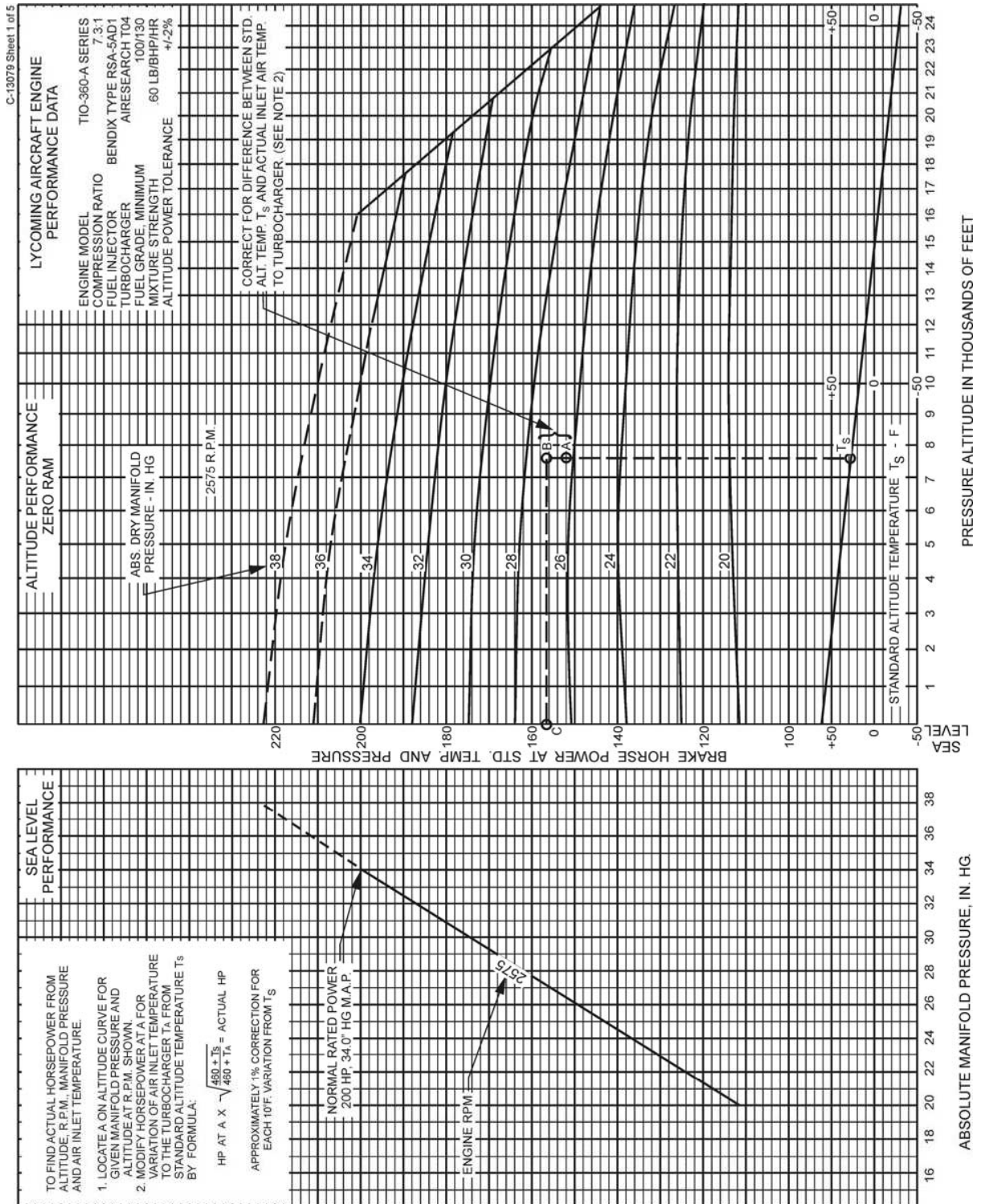

Figure 3-31. Sea Level and Altitude Performance – TIO-360-A Series (Sheet 1 of 5)

**SECTION 3
OPERATING INSTRUCTIONS**

**LYCOMING OPERATOR'S MANUAL
O-360 AND ASSOCIATED MODELS**

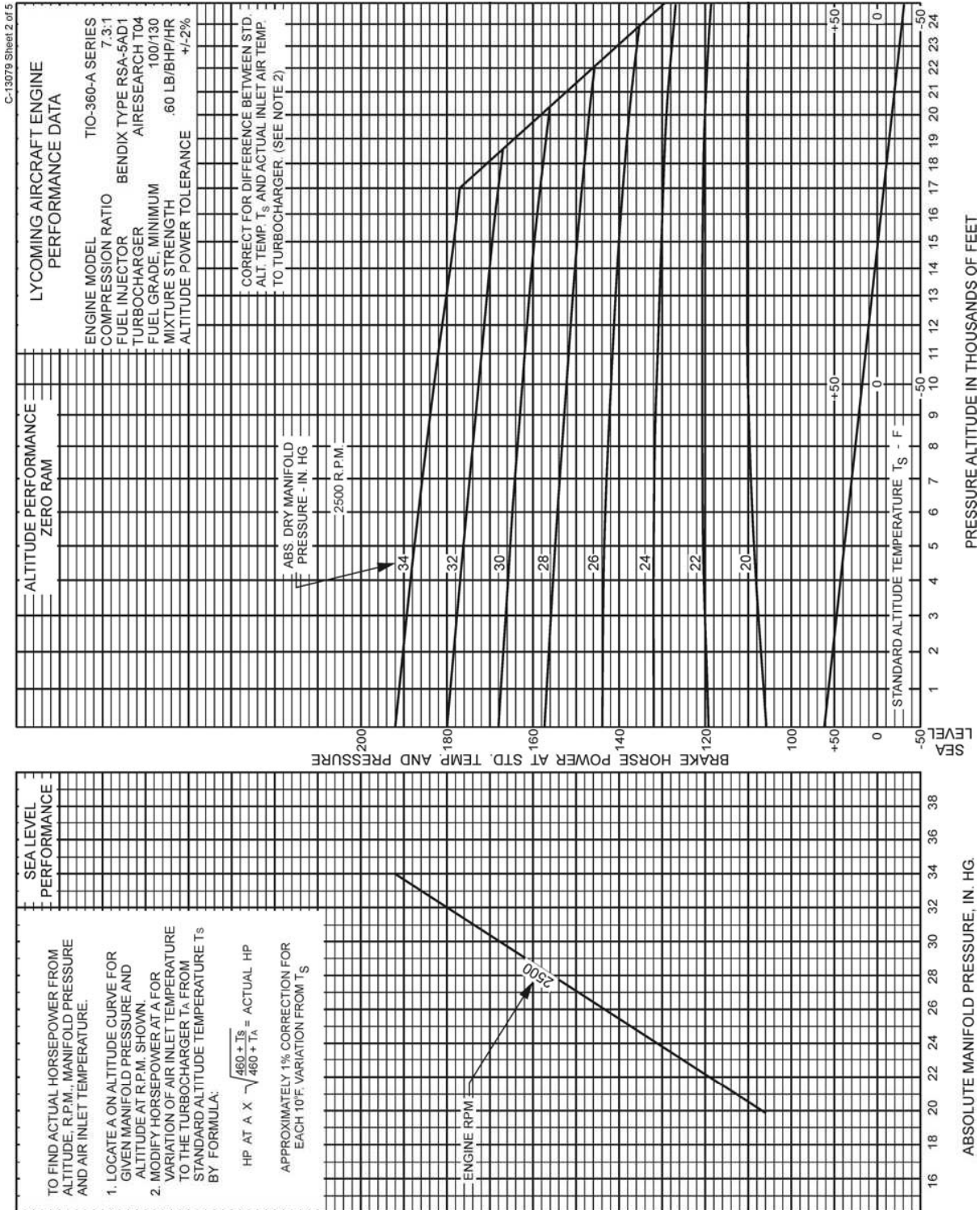

Figure 3-32. Sea Level and Altitude Performance – TIO-360-A Series (Sheet 2 of 5)

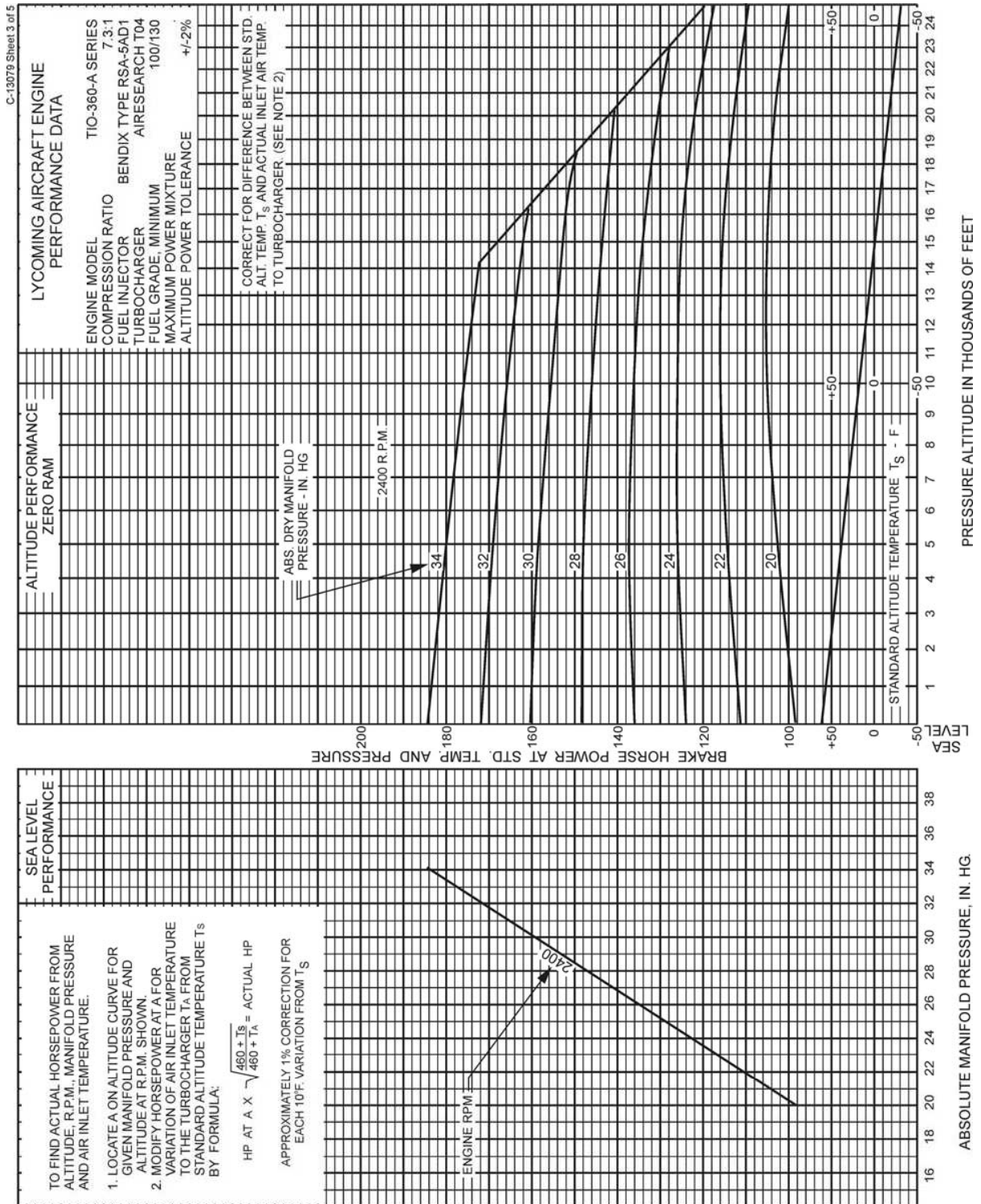

Figure 3-33. Sea Level and Altitude Performance – TIO-360-A Series (Sheet 3 of 5)

**SECTION 3
OPERATING INSTRUCTIONS**

**LYCOMING OPERATOR'S MANUAL
O-360 AND ASSOCIATED MODELS**

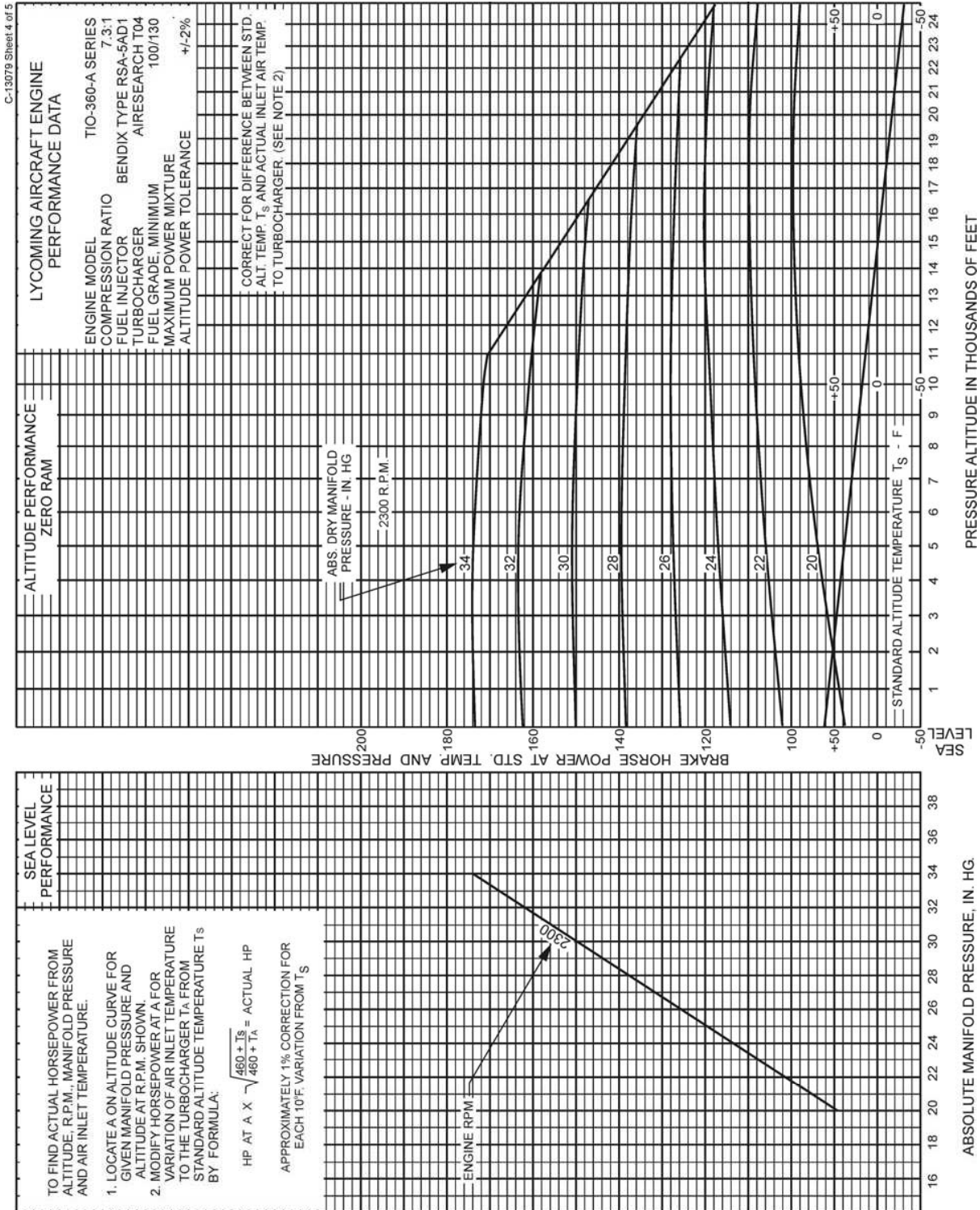

Figure 3-34. Sea Level and Altitude Performance – TIO-360-A Series (Sheet 4 of 5)

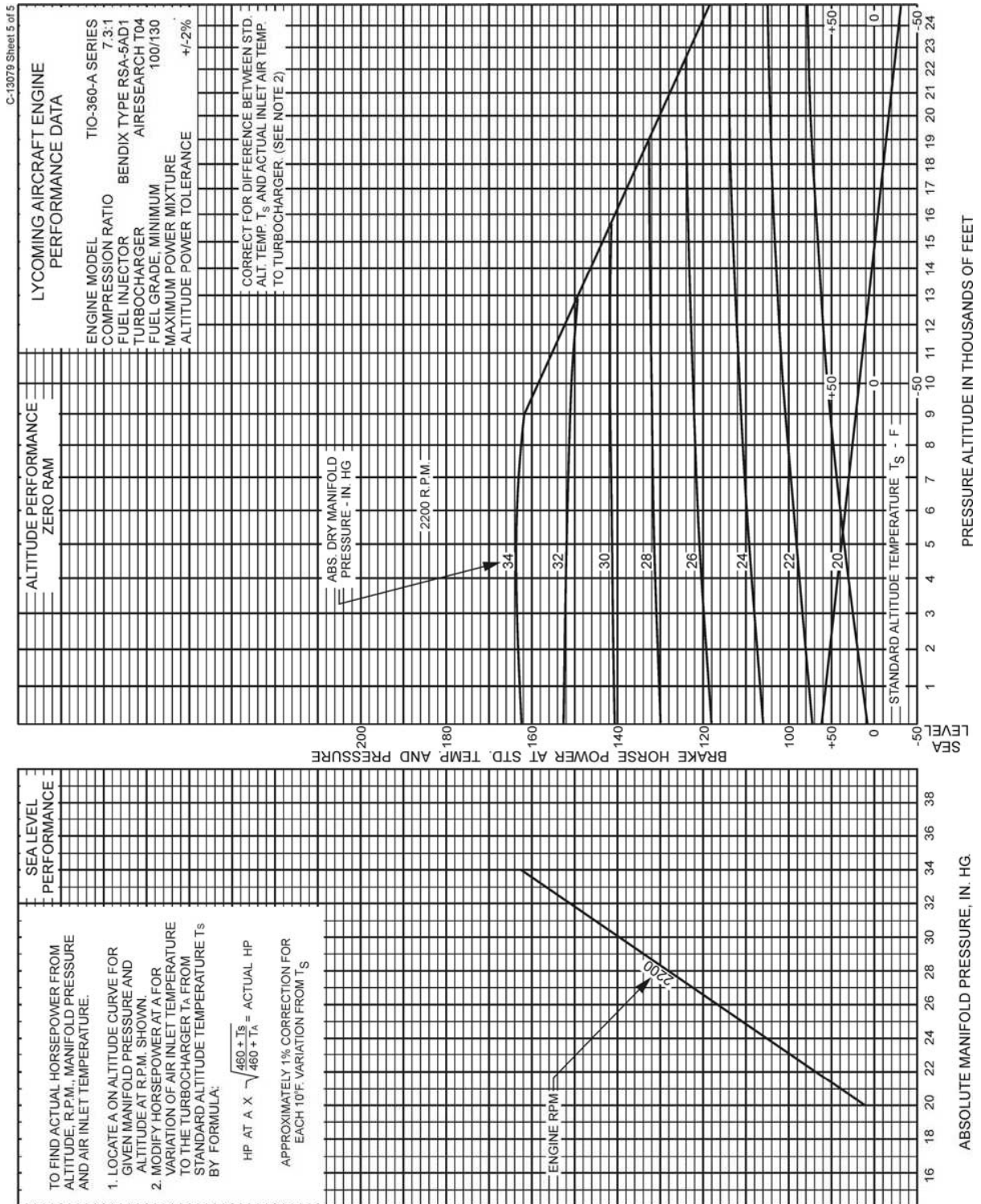

Figure 3-35. Sea Level and Altitude Performance – TIO-360-A Series (Sheet 5 of 5)

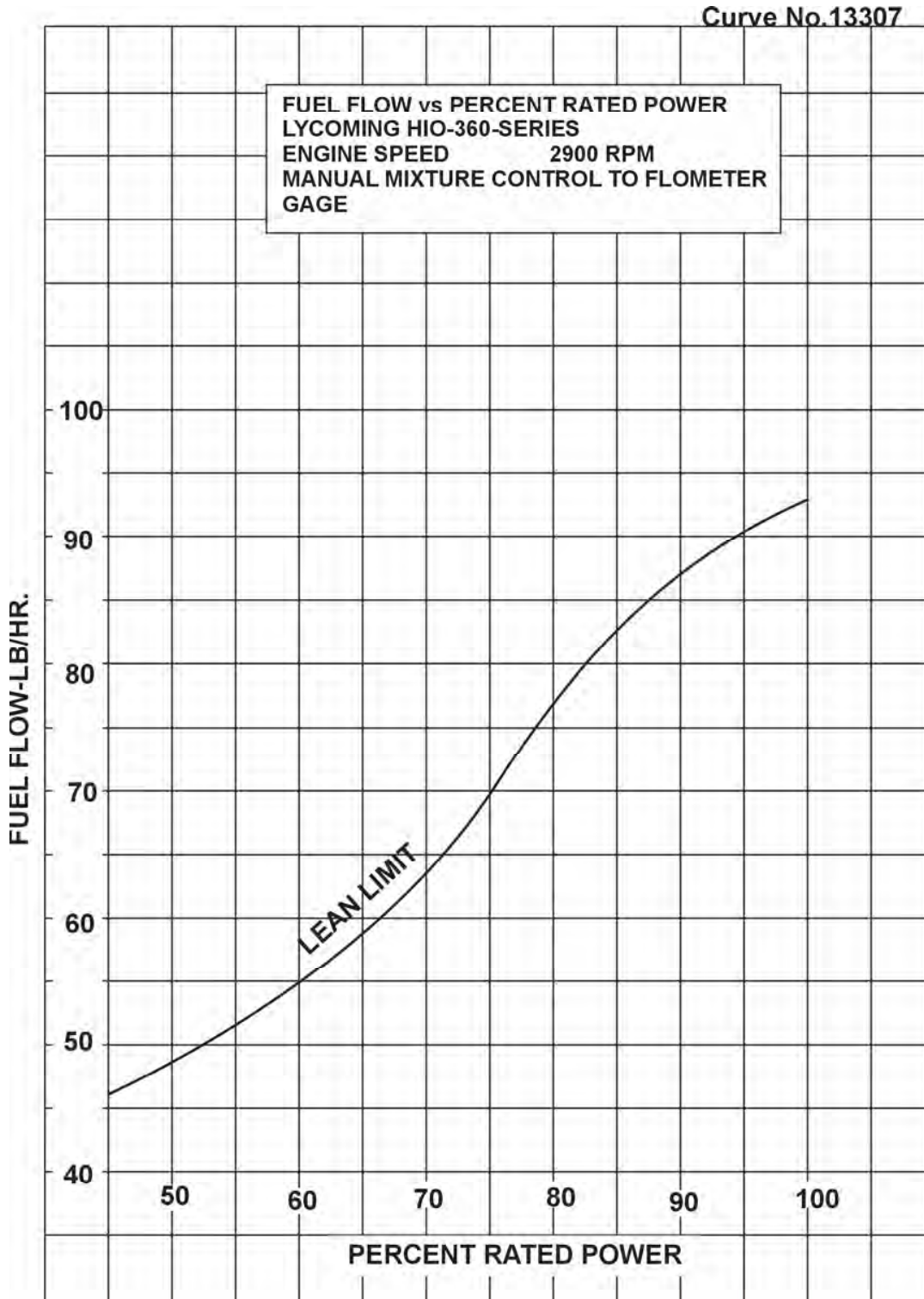

Figure 3-36. Fuel Flow vs Percent Rated Power –
HIO-360-E, -F Series

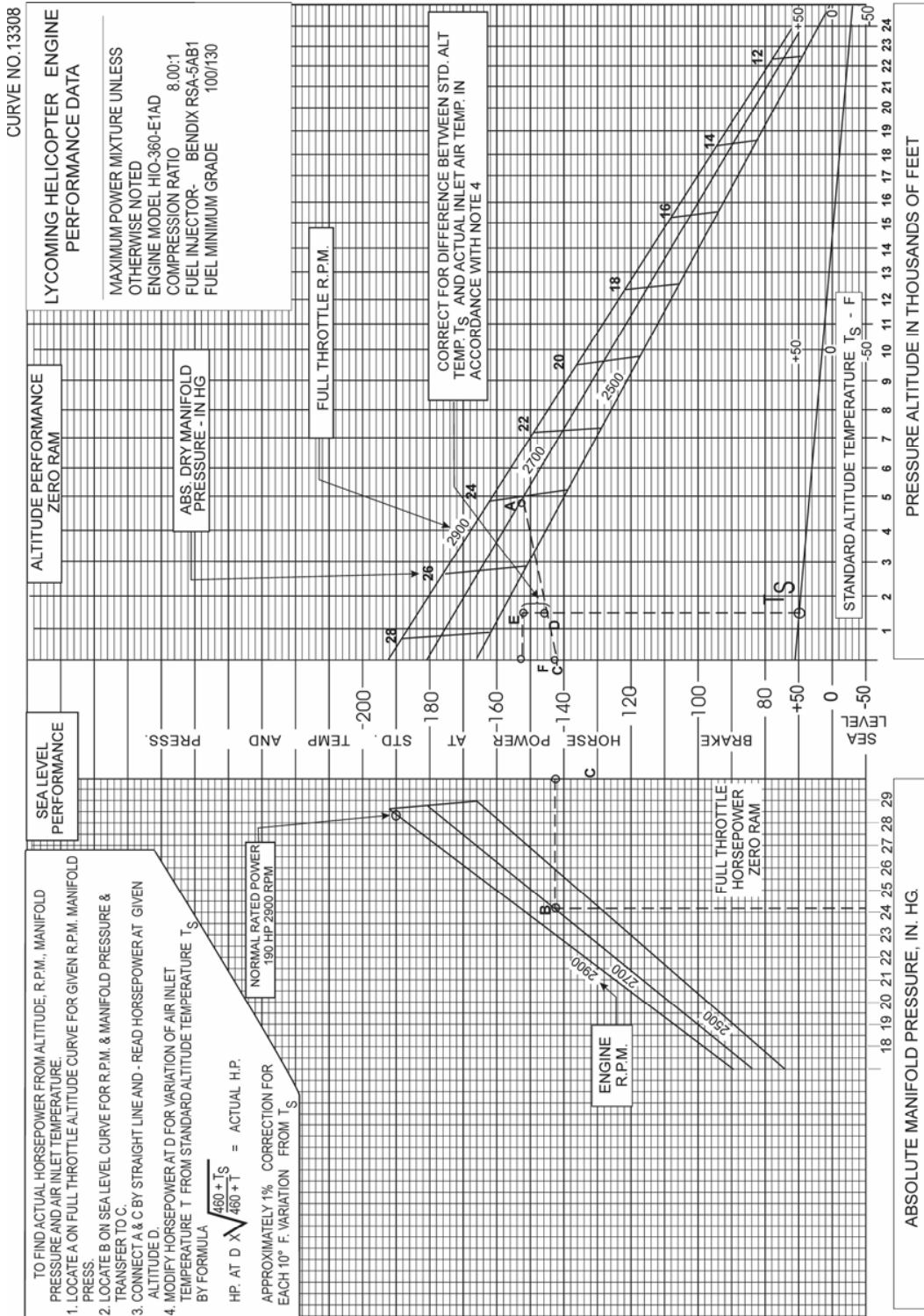

Figure 3-37. Sea Level and Altitude Performance – HIO-360-E Series

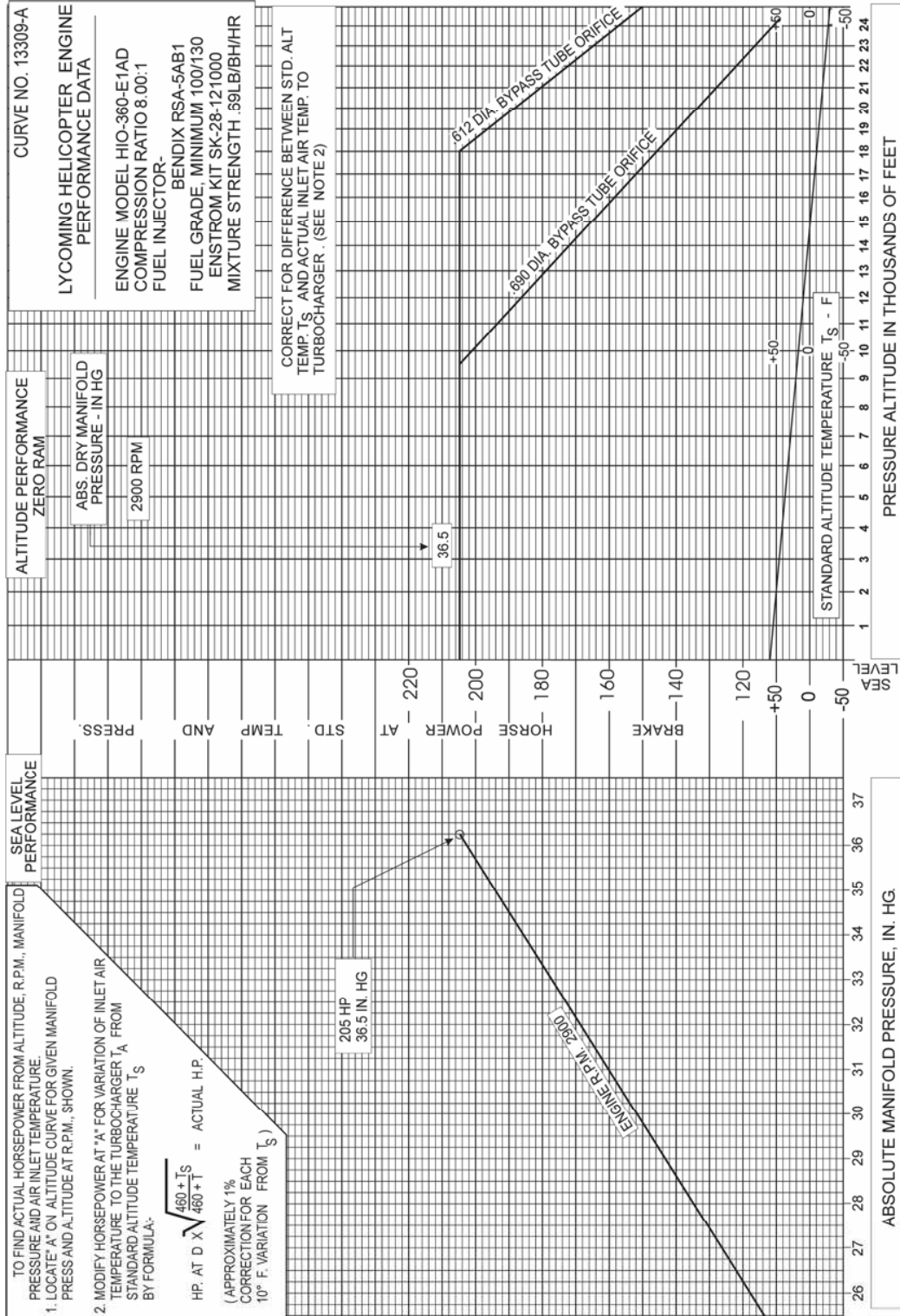

Figure 3-38. Sea Level and Altitude Performance with Turbocharger Kit SK-28-12100 – HIO-360-E Series

FUEL FLOW VS. PERCENT RATED POWER
LYCOMING O-360, 180 HP SERIES
COMPRESSION RATIO 8.50:1
SPARK ADVANCE 25° BTC

CURVE NO.13357

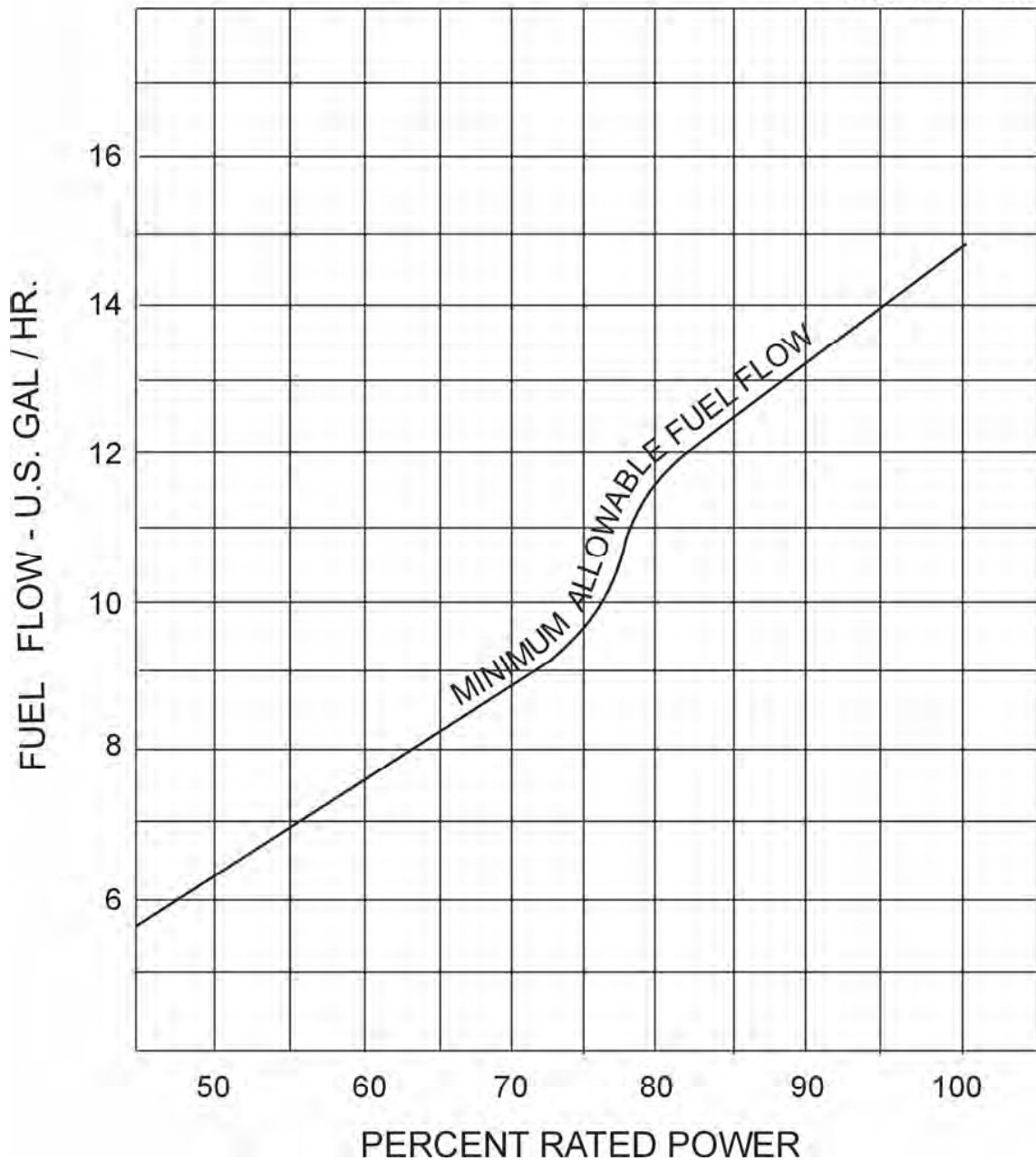

Figure 3-39. Fuel Flow vs Percent Rated Power –
O-360-A, -C, -F, -G Series; HO-360-C1A

Curve No. 13514

FUEL FLOW VS. PERCENT RATED POWER
LYCOMING O-360-J 145 HP
COMPRESSION RATIO 8.5:1
SPARK ADVANCE 25° BTC

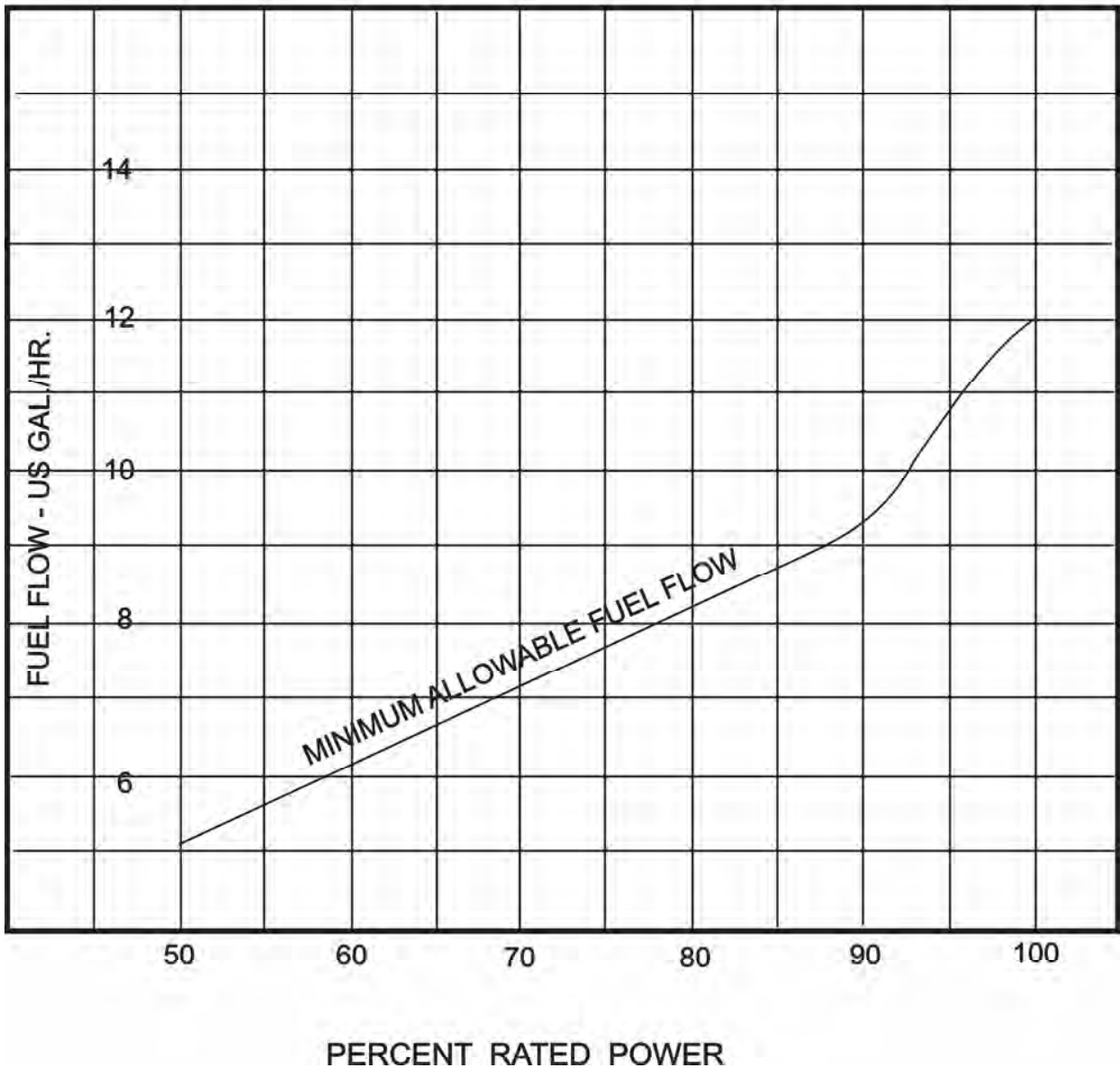

Figure 3-40. Fuel Flow vs Percent Rated Power –
O-360-J2A

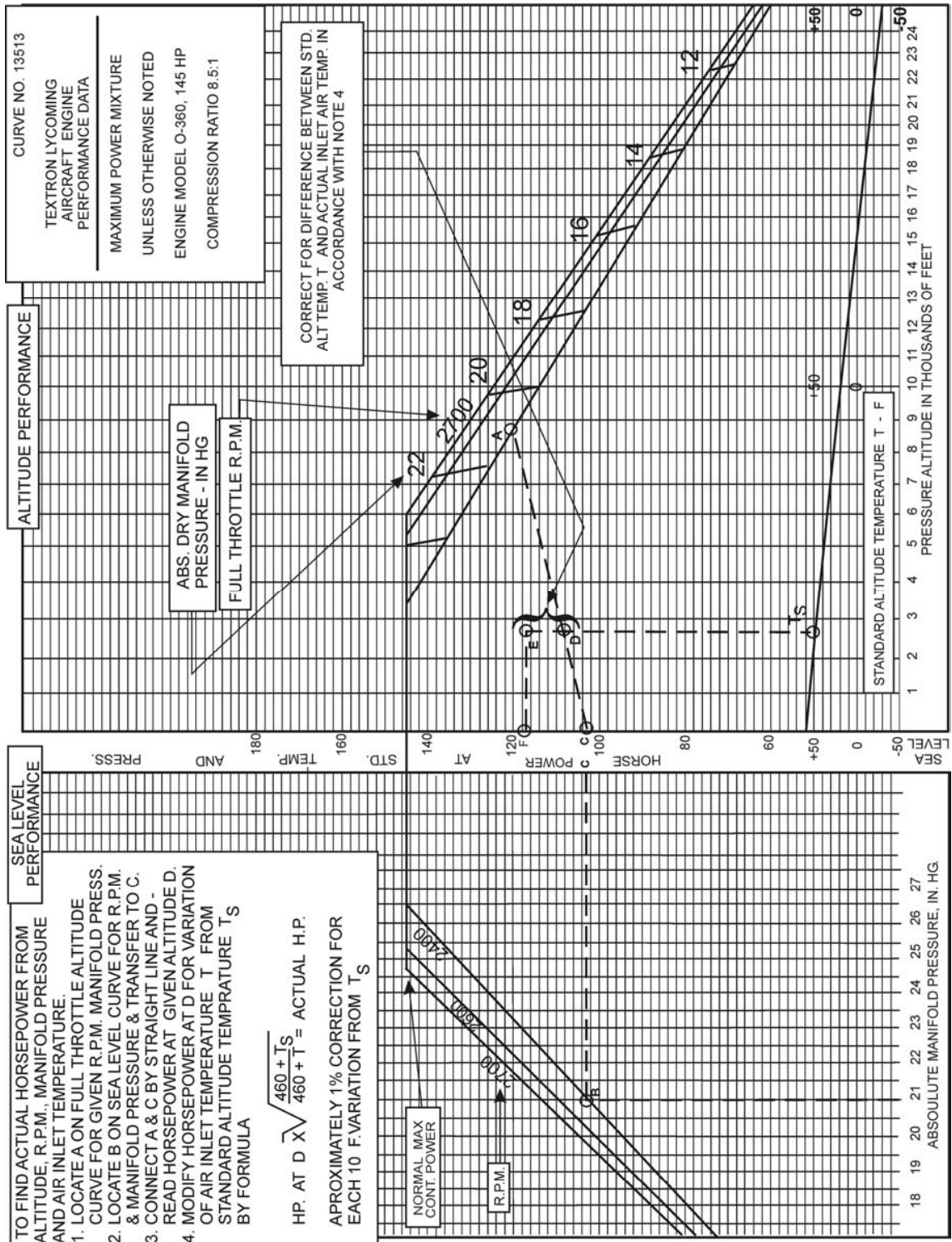

Figure 3-41. Sea Level and Altitude Performance – O-360-J2A

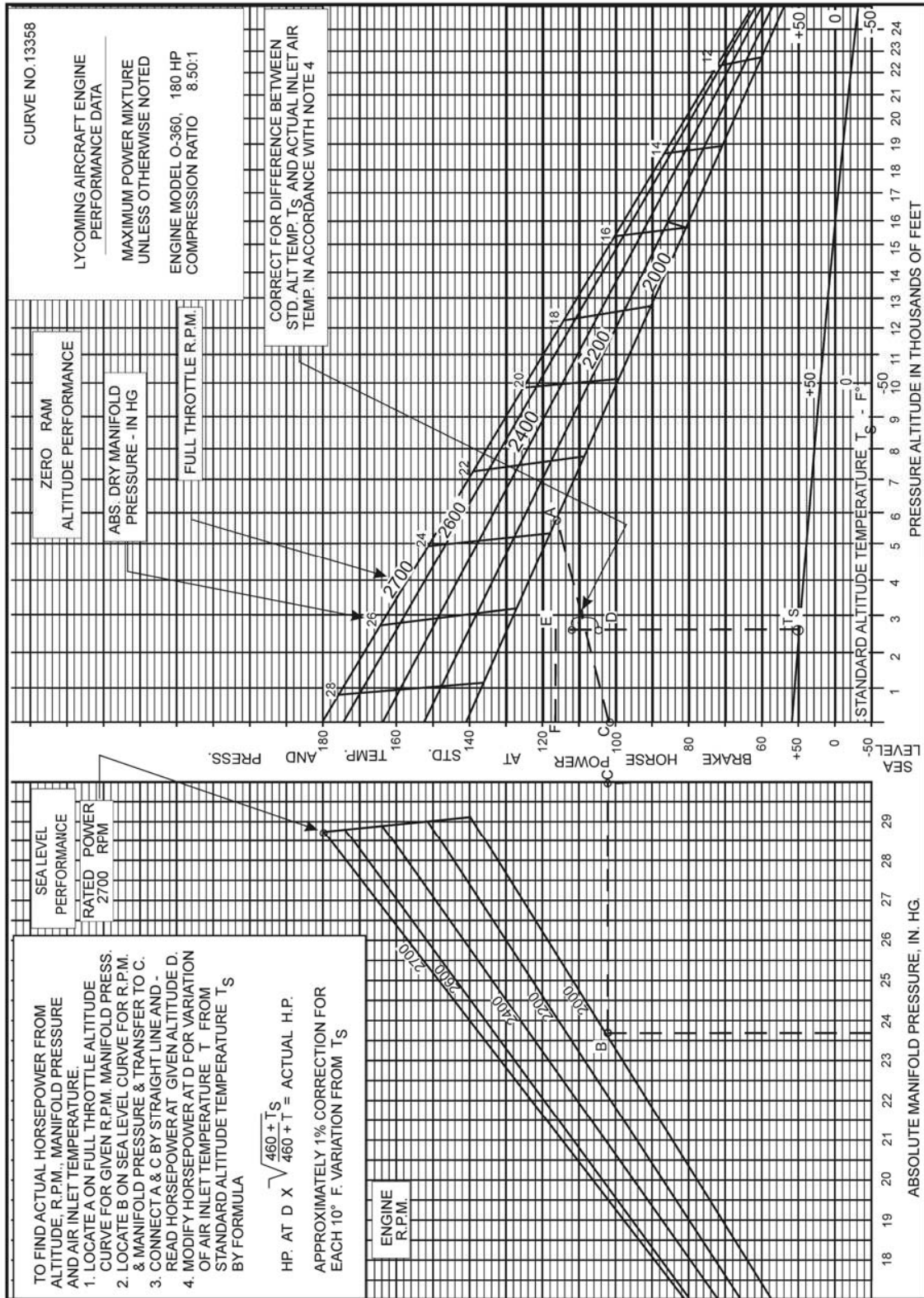

Figure 3-42. Sea Level and Altitude Performance –
O-360-A1A, -A1D, -A1P, -A2A, -A2D, -A2F, -A3A, -A4A, -A4D, -A4M,
-A4N, -A4P, -A1F6, -A1H6, -C1F, -C1G, -C4F, -C4P, -F1A6; HO-360-C1A

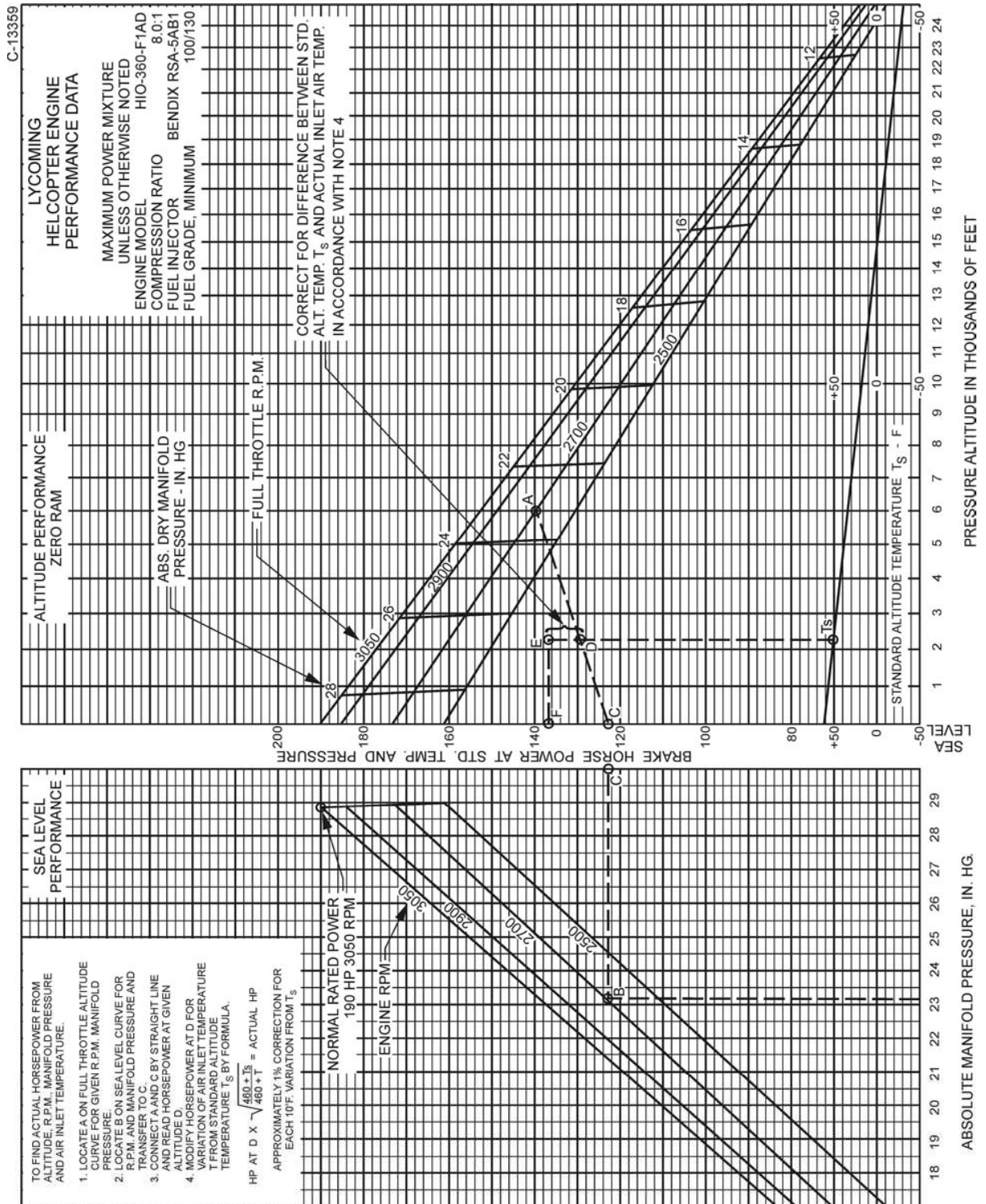

Figure 3-43. Sea Level and Altitude Performance – HIO-360-F Series

**SECTION 3
OPERATING INSTRUCTIONS**

**LYCOMING OPERATOR'S MANUAL
O-360 AND ASSOCIATED MODELS**

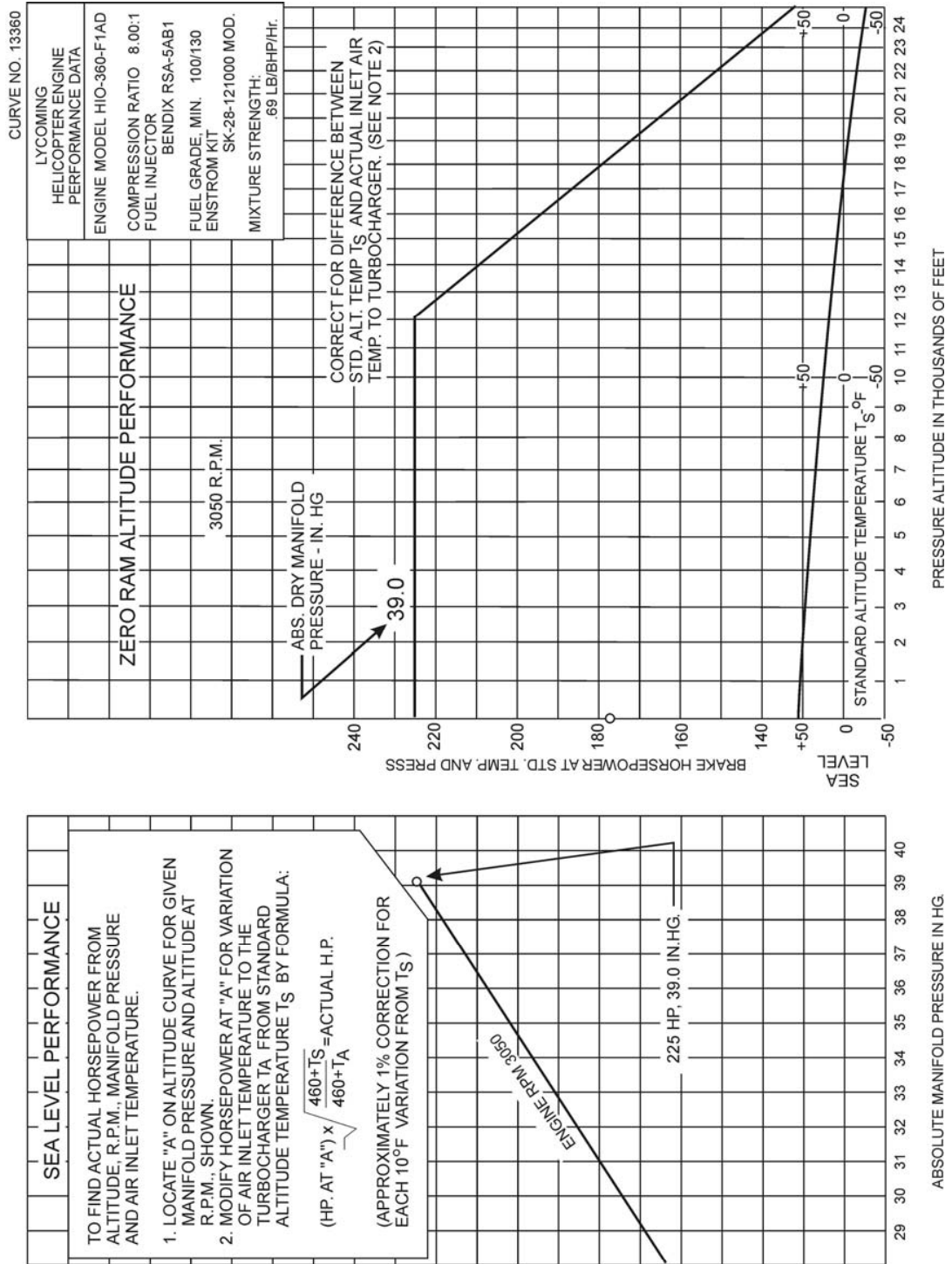

Figure 3-44. Sea Level and Altitude Performance with Turbocharger Kit SK-28-121000 – HIO-360-F Series

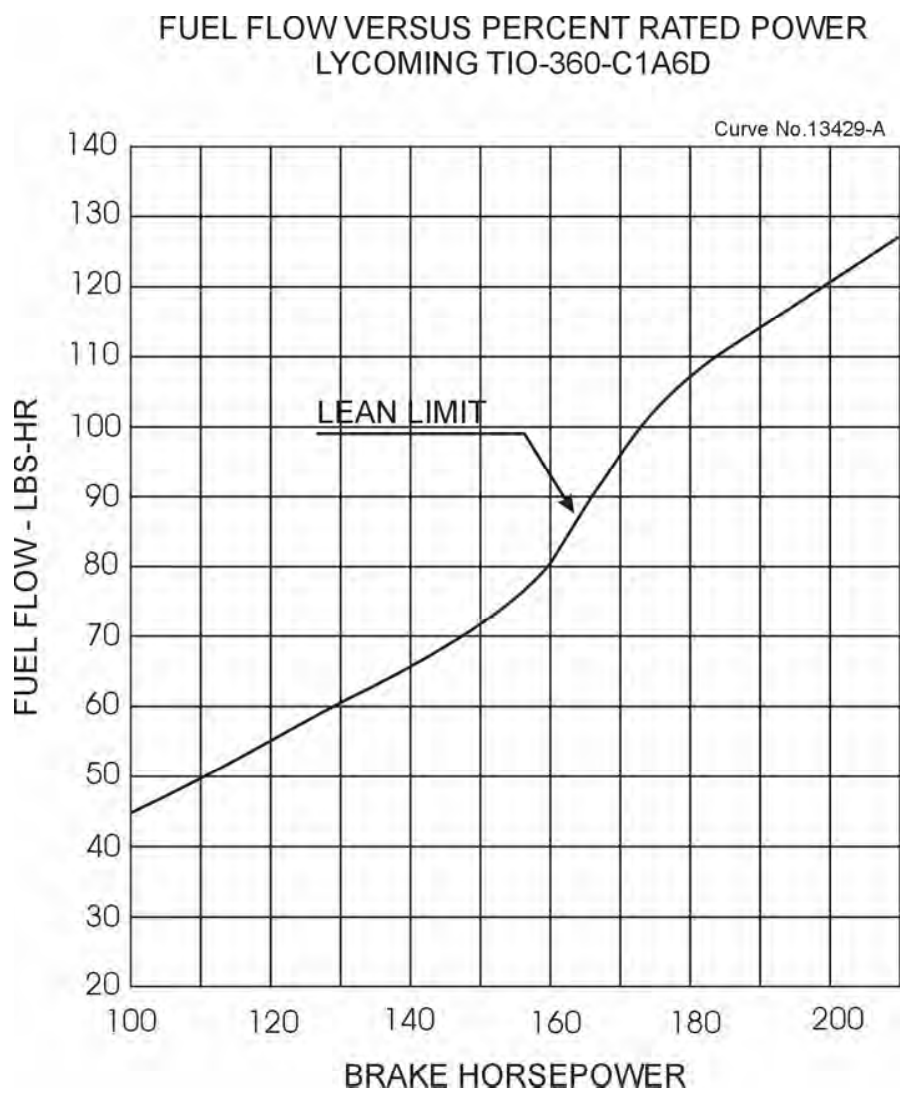

Figure 3-45. Fuel Flow vs Brake Horsepower –
TIO-360-C1A6D

SECTION 3
OPERATING INSTRUCTIONS

LYCOMING OPERATOR'S MANUAL
O-360 AND ASSOCIATED MODELS

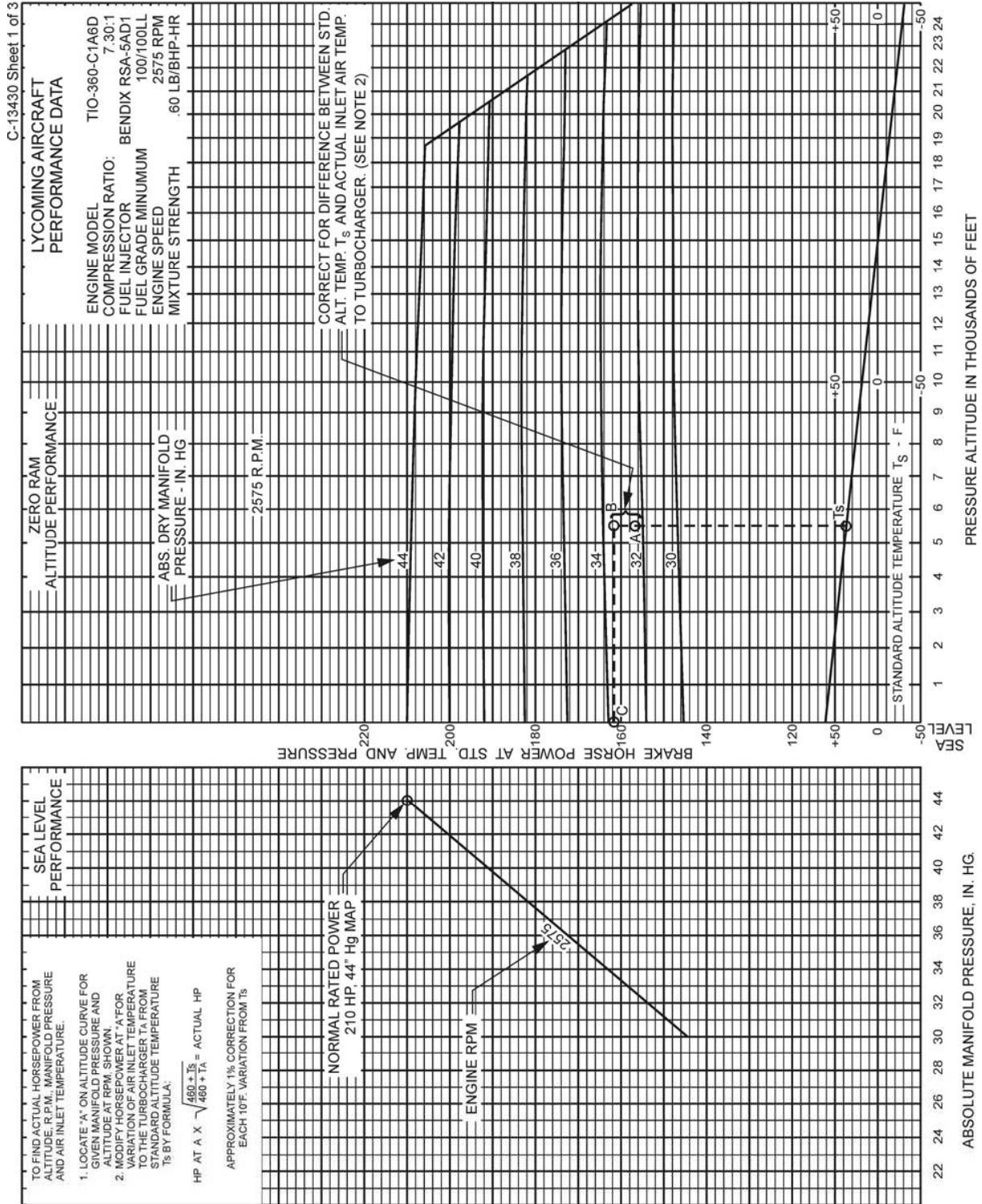

Figure 3-46. Sea Level and Altitude Performance – TIO-360-C1A6D (Sheet 1 of 3)

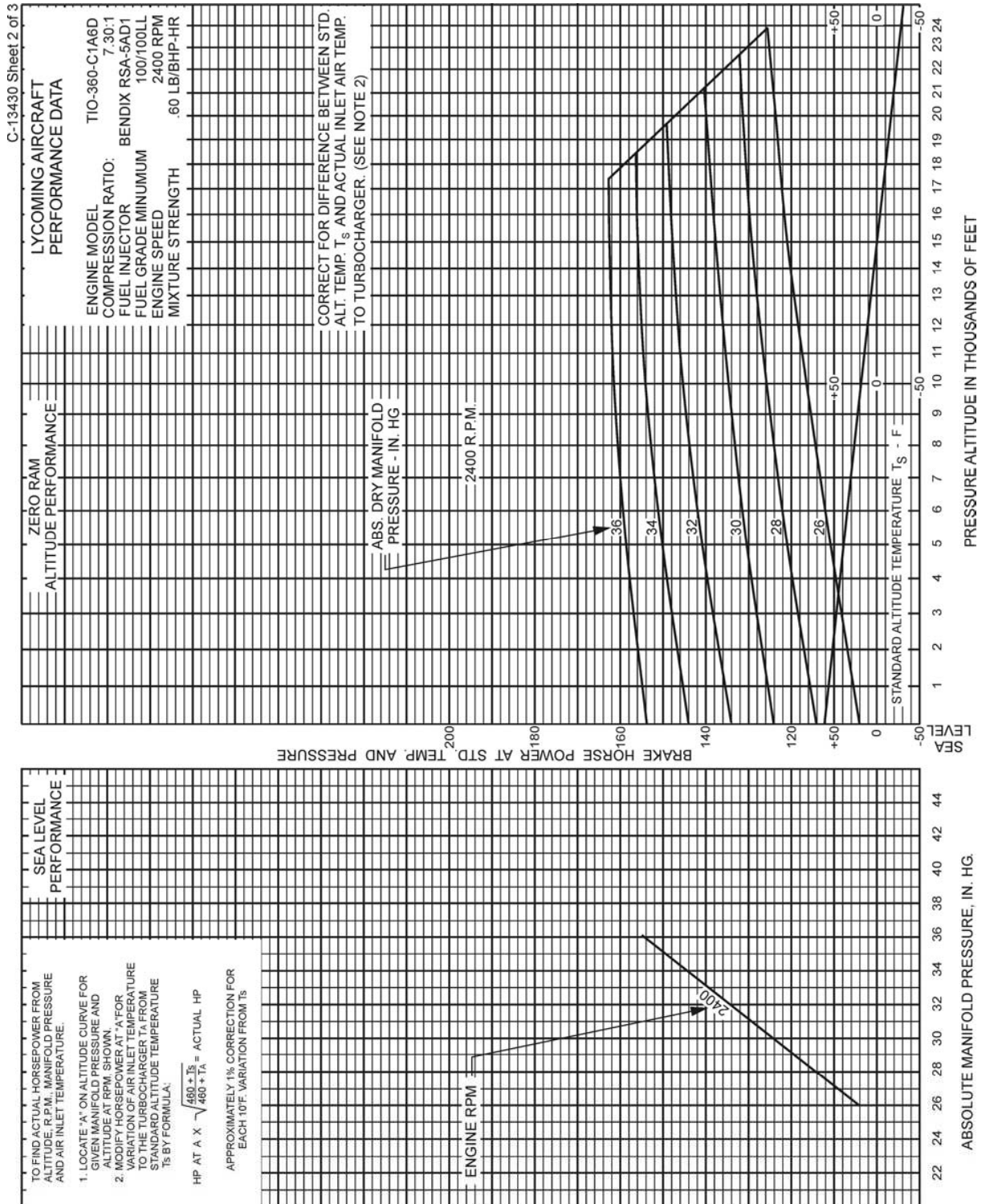

Figure 3-47. Sea Level and Altitude Performance – TIO-360-C1A6D (Sheet 2 of 3)

**SECTION 3
OPERATING INSTRUCTIONS**

**LYCOMING OPERATOR'S MANUAL
O-360 AND ASSOCIATED MODELS**

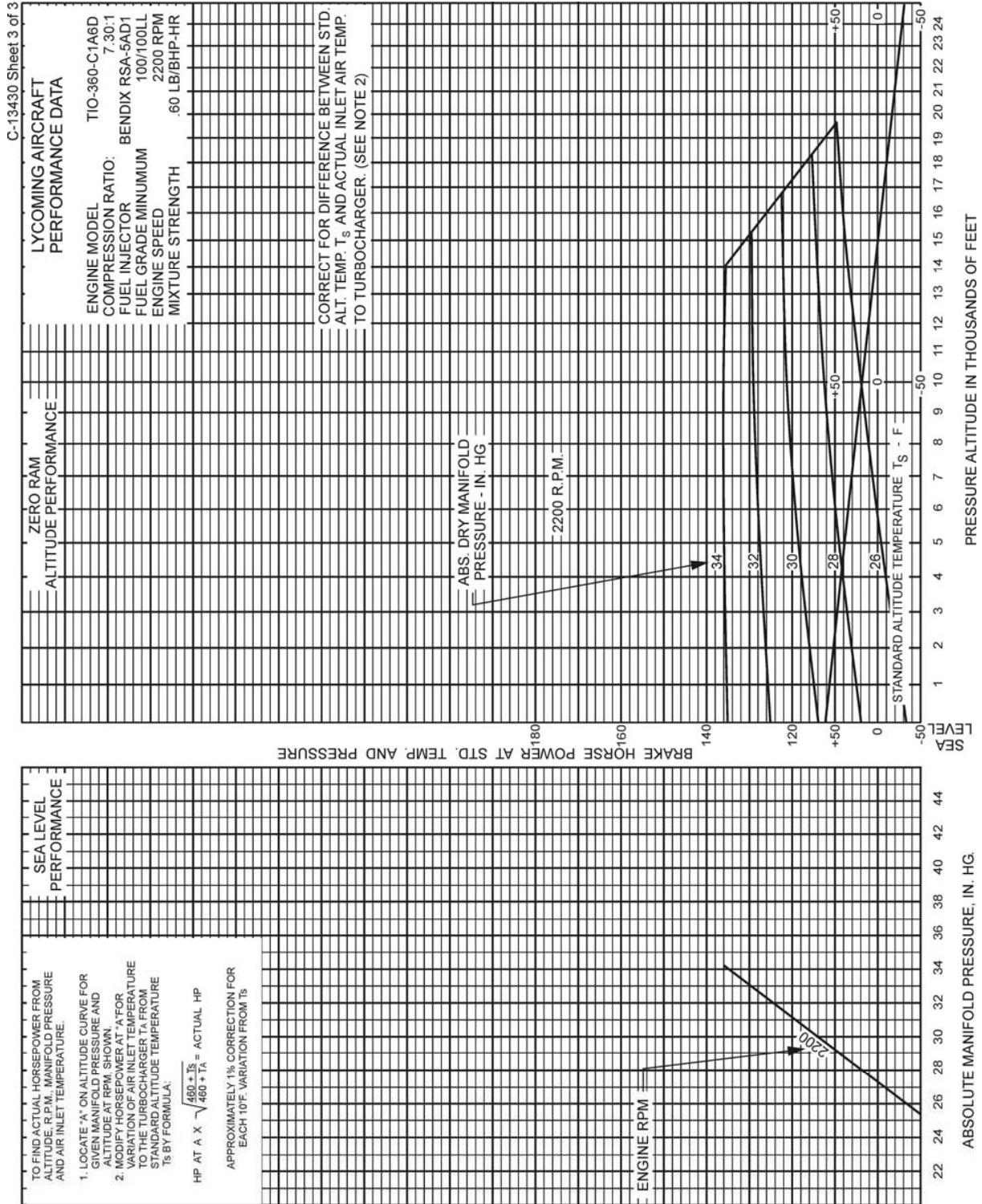

Figure 3-48. Sea Level and Altitude Performance – TIO-360-C1A6D (Sheet 3 of 3)

**SECTION 4
PERIODIC INSPECTIONS**

NOTE

Perhaps no other factor is quite so important to safety and durability of the aircraft and its components as faithful and diligent attention to regular checks for minor troubles and prompt repair when they are found.

The operator should bear in mind that the items listed in the following pages do not constitute a complete aircraft inspection, but are meant for the engine only. Consult the airframe manufacturer's handbook for additional instructions.

Pre-Starting Items of Maintenance – The daily pre-flight inspection is a check of the aircraft prior to the first flight of the day. The inspection is to determine the general condition of the aircraft and engine.

The importance of proper pre-flight inspection cannot be over emphasized. Statistics prove several hundred accidents occur yearly directly responsible to poor pre-flight.

Among the major causes of poor pre-flight inspection are lack of concentration, reluctance to acknowledge the need for a check list, carelessness bred by familiarity and haste.

SECTION 4
PERIODIC INSPECTIONS

LYCOMING OPERATOR'S MANUAL
O-360 AND ASSOCIATED MODELS

1. DAILY PRE-FLIGHT.

a. Engine.

- (1) Be sure all switches are in the "Off" position.
- (2) Be sure magneto ground wires are connected.
- (3) Check oil level.
- (4) See that fuel tanks are full.
- (5) Check fuel and oil line connections; note minor indications for repair at 50-hour inspection. Repair any leaks before aircraft is flown.
- (6) Open the fuel drain to remove any accumulation of water and sediment.
- (7) Make sure all shields and cowling are in place and secure. If any are missing or damaged, repair or replacement should be made before the aircraft is flown.
- (8) Check controls for general condition, travel, and freedom of movement.
- (9) Induction system air filter should be inspected and serviced in accordance with the airframe manufacturer's recommendations.

b. Turbocharger.

- (1) Inspect mounting and connections of turbocharger for security, lubricant or air leakage.
- (2) Check engine crankcase breather for restrictions to breather.

2. 25-HOUR INSPECTION (ENGINE). After the first twenty-five hours operation time; new, rebuilt or newly overhauled engines should undergo a 50-hour inspection including draining and renewing lubricating oil. If engine has no full-flow oil filter, change oil every 25 hours. Also, inspect and clean suction and pressure screens.

3. 50-HOUR INSPECTION (ENGINE). In addition to the items listed for daily pre-flight inspection, the following maintenance checks should be made after every 50 hours of operation.

a. Ignition System.

- (1) If fouling of spark plugs is apparent, rotate bottom plugs to upper position.
- (2) Examine spark plug leads of cable and ceramics for corrosion deposits. This condition is evidence of either leaking spark plugs, improper cleaning of the spark plug walls or connector ends. Where this condition is found, clean the cable ends, spark plug walls and ceramics with a dry, clean cloth or a clean cloth moistened with methyl-ethyl-ketone. All parts should be clean and dry before reassembly.

- (3) Check ignition harness for security of mounting clamps and be sure connections are tight at spark plug and magneto terminals.
- b. Fuel and Induction System* – Check the primer lines for leaks and security of the clamps. Remove and clean the fuel inlet strainers. Check the mixture control and throttle linkage for travel, freedom of movement, security of the clamps and lubricate if necessary. Check the air intake ducts for leaks, security, filter damage; evidence of dust or other solid material in the ducts is indicative of inadequate filter care or damaged filter. Check vent lines for evidence of fuel or oil seepage; if present, fuel pump may require replacement.
- c. Lubrication System.*
- (1) Replace external full flow oil filter element. (Check used element for metal particles.) Drain and renew lubricating oil.
 - (2) (*Engines Not Equipped with External Filter.*) Remove oil pressure screen and clean thoroughly. Note carefully for presence of metal particles that are indicative of internal engine damage. Change oil every 25 hours.
 - (3) Check oil lines for leaks, particularly at connections for security of anchorage and for wear due to rubbing or vibration, for dents and cracks.
- d. Exhaust System* – Check attaching flanges at exhaust ports on cylinder for evidence of leakage. If they are loose, they must be removed and machined flat before they are reassembled and tightened. Examine exhaust manifolds for general condition.
- e. Cooling System* – Check cowling and baffle for damage and secure anchorage. Any damaged or missing part of the cooling system must be repaired or replaced before the aircraft resumes operation.
- f. Cylinders* – Check rocker box cover for evidence of oil leaks. If found, replace gasket and tighten screws to specified torque (50 in.-lbs.).

Check cylinders for evidence of excessive heat which is indicated by burned paint on the cylinder. This condition is indicative of internal damage to the cylinder and, if found, its cause must be determined and corrected before the aircraft resumes operation.

Heavy discoloration and appearance of seepage at cylinder head and barrel attachment area is usually due to emission of thread lubricant used during assembly of the barrel at the factory, or by slight gas leakage which stops after the cylinder has been in service for awhile. This condition is neither harmful nor detrimental to engine performance and operation. If it can be proven that leakage exceeds these conditions, the cylinder should be replaced.

- g. Turbocharger* – All fluid power lines and mounting brackets incorporated in turbocharger system should be checked for leaks, tightness and any damage that may cause a restriction.

Check for accumulation of dirt or other interference with the linkage between the bypass valve and the actuator which may impair operation of turbocharger. Clean or correct cause of interference.

SECTION 4 PERIODIC INSPECTION

LYCOMING OPERATOR'S MANUAL O-360 AND ASSOCIATED MODELS

The vent line from the actuator should be checked for oil leakage. Any constant oil leakage is cause for replacement of piston seal.

Check alternate air valve to be sure it swings free and seals tightly.

- h. Carburetor* – Check throttle body attaching screws for tightness. The correct torque for these screws is 40-50 in.-lbs.

4. *100-HOUR INSPECTION*. In addition to the items listed for daily pre-flight and 50-hour inspection, the following maintenance checks should be made after every one hundred hours of operation.

a. Electrical System.

(1) Check all wiring connected to the engine or accessories. Any shielded cables that are damaged should be replaced. Replace clamps or loose wires and check terminals for security and cleanliness.

(2) Remove spark plugs; test, clean and regap. Replace if necessary.

b. Lubrication System – Drain and renew lubricating oil.

c. Magnetos – Check breaker points for pitting and minimum gap. Check for excessive oil in the breaker compartment, if found, wipe dry with a clean lintless cloth. The felt located at the breaker points should be lubricated in accordance with the magneto manufacturer's instructions. Check magneto to engine timing. Timing procedure is described in Section 5, 1, b of this manual.

d. Engine Accessories – Engine mounted accessories such as pumps, temperature and pressure sensing units should be checked for secure mounting, tight connections.

e. Cylinders – Check cylinders visually for cracked or broken fins.

f. Engine Mounts – Check engine mounting bolts and bushings for security and excessive wear. Replace any bushings that are excessively worn.

g. Fuel Injection Nozzles and Fuel Lines – Check fuel injector nozzles for looseness, tighten to 60 in.-lbs. torque. Check fuel line for dye stains at connection indicating leakage and security of line. Repair or replacement must be accomplished before the aircraft resumes operation.

h. Turbocharger – Inspect all air ducting and connections in turbocharger system for leaks. Make inspection both with engine shut down and with engine running. Check at manifold connections to turbine inlet and at engine exhaust manifold gasket, for possible exhaust gas leakage.

CAUTION

DO NOT OPERATE THE TURBOCHARGER IF LEAKS EXIST IN THE DUCTING, OR IF AIR CLEANER IS NOT FILTERING EFFICIENTLY. DUST LEAKING INTO AIR DUCTING CAN DAMAGE TURBOCHARGER AND ENGINE.

Check for dirt or dust build-up within the turbocharger. Check for uneven deposits on the impeller. Consult AiResearch Div. Manual TP-21 for method to remove all such foreign matter.

5. *400-HOUR INSPECTION.* In addition to the items listed for daily pre-flight, 50-hour and 100-hour inspection, the following maintenance check should be made after every 400 hours of operation.

Valve Inspection – Remove rocker box covers and check for freedom of valve rockers when valves are closed. Look for evidence of abnormal wear or broken parts in the area of the valve tips, valve keeper, springs and spring seats. If any indications are found, the cylinder and all of its components should be removed (including the piston and connecting rod assembly) and inspected for further damage. Replace any parts that do not conform with limits shown in the latest revision of Special Service Publication No. SSP1776.

6. *NON-SCHEDULED INSPECTIONS.* Occasionally, Service Bulletins or Service Instructions are issued by Lycoming that require inspection procedures that are not listed in this manual. Such publications usually are limited to specified engine models and become obsolete after corrective modification has been accomplished. All such publications are available from Lycoming distributors, or from the factory by subscription. Consult the latest revision of Service Letter No. L114 for subscription information. Maintenance facilities should have an up-to-date file of these publications available at all times.

This Page Intentionally Left Blank

LYCOMING OPERATOR'S MANUAL

SECTION 5 MAINTENANCE PROCEDURES

	Page
General.....	5-1
Ignition and Electrical System	
Ignition Harness and Wire Replacement.....	5-1
Timing Magneto to Engine	
Single Magneto	5-1
Dual Magneto	5-1
Generator or Alternator Output	5-4
Fuel System	
Repair of Fuel Leaks.....	5-4
Carburetor or Fuel Injector Inlet Screen Assembly.....	5-4
Fuel Grades and Limitations	5-4
Air Intake Ducts and Filter	5-4
Idle Speed and Mixture Adjustment.....	5-4
Lubrication System	
Oil Grades and Limitations.....	5-4
Oil Suction and Oil Pressure Screens	5-5
Oil Pressure Relief Valve.....	5-5
Cylinders.....	5-5
Generator or Alternator Drive Belt Tension.....	5-9
Turbocharger Controls	5-9

This Page Intentionally Left Blank

SECTION 5

MAINTENANCE PROCEDURES

The procedures described in this section are provided to guide and instruct personnel in performing such maintenance operations that may be required in conjunction with the periodic inspections listed in the preceding section. No attempt is made to include repair and replacement operations that will be found in the applicable Lycoming Overhaul Manual.

1. IGNITION AND ELECTRICAL SYSTEM.

- a. *Ignition Harness and Wire Replacement* – In the event that an ignition harness or an individual lead is to be replaced, consult the wiring diagram to be sure harness is correctly installed. Mark location of clamps and clips to be certain the replacement is clamped at correct locations.
- b. *Timing Magnetos to Engine.*
 - (1) Remove a spark plug from No. 1 cylinder and place a thumb over the spark plug hole. Rotate the crankshaft in direction of normal rotation until the compression stroke is reached, this is indicated by a positive pressure inside the cylinder tending to push the thumb off the spark plug hole. Continue rotating the crankshaft until the advance timing mark on the front face of the starter ring gear is in alignment with the small hole located at the two o'clock position on the front face of the starter housing. (Ring gear may be marked at 20° and 25°. Consult specifications for correct timing mark of your installation.) At this point, the engine is ready for assembly of the magnetos.
 - (2) *Single Magneto* – Remove the inspection plugs from both magnetos and turn the drive shaft in direction of normal rotation until (-20 and -200 series) the first painted chamfered tooth on the distributor gear is aligned in the center of the inspection window; (-1200 series) the applicable timing mark on the distributor gear is approximately aligned with the mark on the distributor block. See Figure 5-2. Being sure the gear does not move from this position, install gaskets and magnetos on the engine. Note that an adapter is used with impulse coupling magneto. Secure with (clamps on -1200 series) washers and nuts; tighten only finger tight.
 - (3) Using a battery powered timing light, attach the positive lead to a suitable terminal connected to the switch terminal of the magneto and the negative lead to any unpainted portion of the engine. Rotate the magneto in its mounting flange to a point where the light comes on, then slowly turn it in the opposite direction until the light goes out. Bring the magneto back slowly until the light just comes on. Repeat this with the second magneto.
 - (4) Back off the crankshaft a few degrees, the timing lights should go out. Bring the crankshaft slowly back in direction of normal rotation until the timing mark and the hole in the starter housing are in alignment. At this point, both lights should go on simultaneously. Tighten nuts to specified torque.
 - (5) *Dual Magnetos* – Remove the timing window plug from the most convenient side of the housing and the plug from the rotor viewing location in the center of the housing.
 - (6) Turn the rotating magnet drive shaft in direction of normal rotation until the painted tooth of the distributor gear is center in the timing hole. Observe that at this time the built in pointer just ahead of the rotor viewing window aligns with either the L or R (depending on rotation).

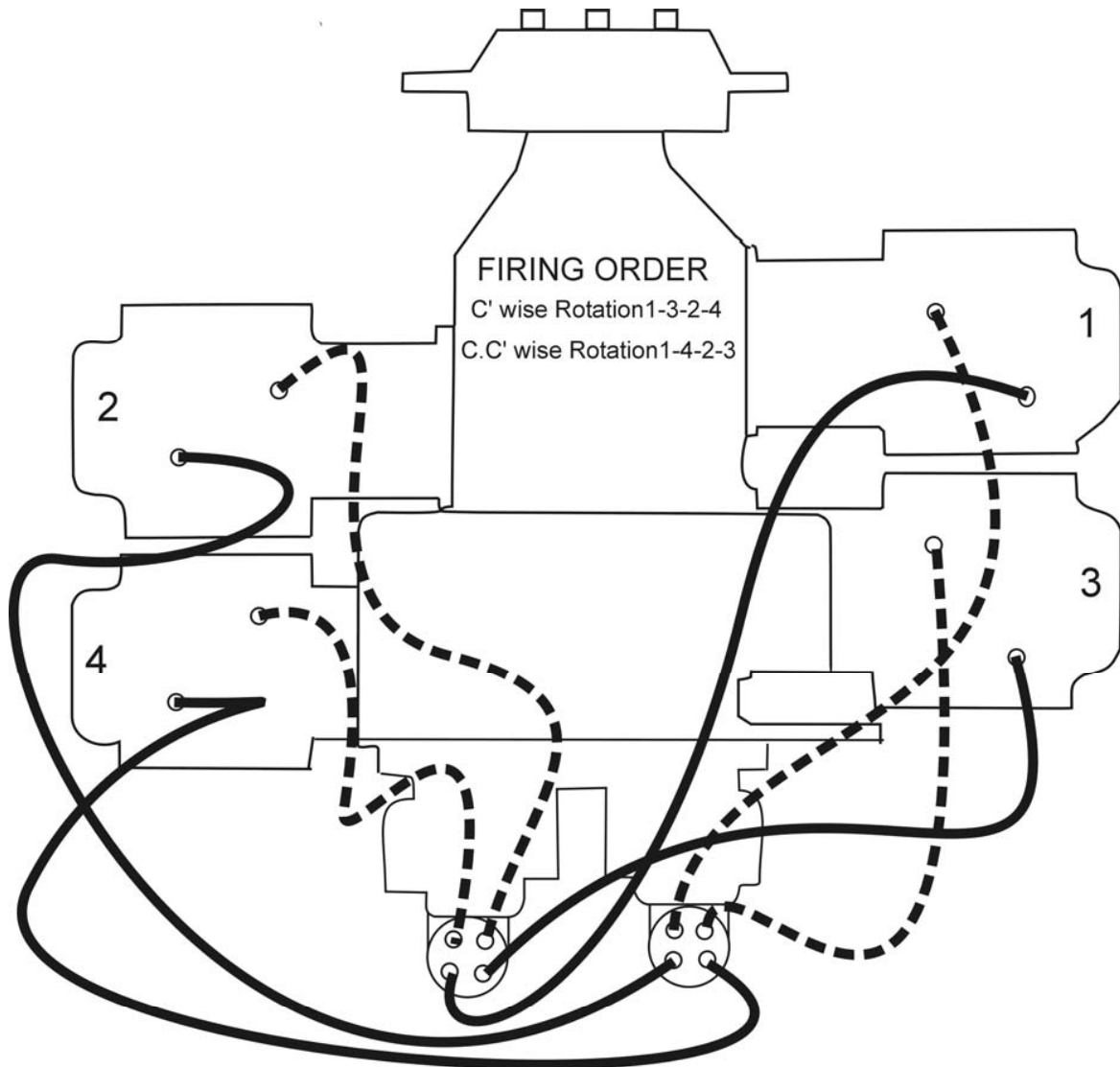

Figure 5-1. Ignition Wiring Diagram

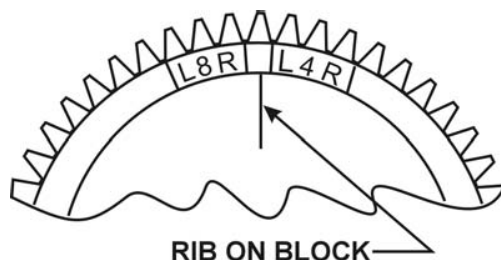

Figure 5-2. Timing Marks – 4 Cylinder -1200 Series

- (7) Hold the magneto in this position and install gasket and magnetos. Secure with clamps, washers and nuts tightened only finger tight.
- (8) Using a battery powered timing light, attach one positive lead to left switch terminal, one positive lead to right switch terminal and the ground lead to the magneto housing.
- (9) Turn the entire magneto in direction of rotation until the timing light comes on, then slowly turn it in the opposite direction until the light goes out. Bring the magneto back slowly until the light just comes on.
- (10) Back off the crankshaft a few degrees, the timing lights should go out. Bring the crankshaft slowly back in direction of normal rotation until the lights just come on. Both lights should go on 2° of No. 1 engine firing position.

NOTE

Some timing lights operate in the reverse manner as described. The light comes on when the breaker points open. Check your timing light instructions.

- c. *Internal Timing – Dual Magneto* – Check the magneto internal timing and breaker synchronization in the following manner.
 - (1) *Main Breakers* – Connect the timing light negative lead to any unpainted surface of the magneto. Connect one positive lead to the left main breaker terminal and the second positive lead to the right main breaker terminal.
 - (2) Back the engine up a few degrees and again bump forward toward number one cylinder firing position while observing timing lights. Both lights should go out to indicate opening of the main breakers when the timing pointer is indicating within the width of the “L” or “R” mark. If breaker timing is incorrect, loosen breaker screws and correct. Retorque breaker screws to 20-25 in.-lbs.
 - (3) *Retard Breaker* – Remove timing light leads from the main breaker terminals. Attach one positive lead to retard breaker terminal, and second positive lead to the tachometer breaker terminal, if used.
 - (4) Back the engine up a few degrees and again bump forward toward number one cylinder firing position until pointer is aligned with 15° retard timing mark. See Figure 5-6. Retard breaker should just open at this position.
 - (5) If retard timing is not correct, loosen cam securing screw and turn the retard breaker cam as required to make retard breaker open per paragraph c (4). Retorque cam screw to 16-20 in.-lbs.
 - (6) Observe the tachometer breaker is opened by the cam lobe. No synchronization of this breaker is required.
 - (7) Check action of impulse coupling (D-2000/3000 series only). With the ignition switch off observe breaker cam end of rotor while manually cranking engine through a firing sequence. Rotor should alternately stop and then (with an audible snap) be rotated rapidly through a retard firing position.

**SECTION 5
MAINTENANCE PROCEDURES**

**LYCOMING OPERATOR'S MANUAL
O-360 AND ASSOCIATED MODELS**

- d. *Generator or Alternator Output* – The generator or alternator (whichever is applicable) should be checked to determine that the specified voltage and current are being obtained.

2. *FUEL SYSTEM.*

- a. *Repair of Fuel Leaks* – In the event a line or fitting in the fuel system is replaced, only a fuel soluble lubricant such as clean engine oil or Loctite Hydraulic Sealant may be used on tapered threads. Do not use Teflon tape or any other form of thread compound. Do not apply sealant to the first two threads.
- b. *Carburetor or Fuel Injector (Except Simmonds Injectors) Fuel Inlet Screen Assembly* – Remove the assembly and check the screen for distortion or openings in the strainer. Replace for either of these conditions. Clean screen assembly in solvent and dry with compressed air and reinstall. The fuel inlet screen assembly is tightened to 35-40 in.-lbs. on carburetors and 65-70 in.-lbs. on fuel injectors. The hex head plug on pressure carburetor is tightened to 160-175 in.-lbs.
- c. *Fuel Grade and Limitations* – The recommended aviation grade fuel for the subject engines is listed in Section 3, Item 8.

In the event that the specified fuel is not available at some locations, it is permissible to use higher octane fuel. Fuel of a lower octane than specified is not to be used. Under no circumstances should automotive fuel be used (regardless of octane rating).

NOTE

It is recommended that personnel be familiar with latest revision of Service Instruction No. 1070 regarding specified fuel for Lycoming engines.

- d. *Air Intake Ducts and Filter* – Check all air intake ducts for dirt or restrictions. Inspect and service air filters as instructed in the airframe manufacturer's handbook.
- e. *Idle Speed and Mixture Adjustment.*
- (1) Start the engine and warm up in the usual manner until oil and cylinder head temperatures are normal.
 - (2) Check magnetos. If the "mag-drop" is normal, proceed with idle adjustment.
 - (3) Set throttle stop screw so that the engine idles at the airframe manufacturer's recommended idling RPM. If the RPM changes appreciably after making idle mixture adjustment during the succeeding steps, readjust the idle speed to the desired RPM.
 - (4) When the idling speed has been stabilized, move the cockpit mixture control lever with a smooth, steady pull toward the "Idle Cut-Off" position and observe the tachometer for any change during the leaning process. Caution must be exercised to return the mixture control to the "Full Rich" position before the RPM can drop to a point where the engine cuts out. An increase of more than 50 RPM while "leaning out" indicates an excessively rich idle mixture. An immediate decrease in RPM (if not preceded by a momentary increase) indicates the idle mixture is too lean.

If step (4) indicates that the idle adjustment is too rich or too lean, turn the idle mixture adjustment in direction required for correction, and check this new position by repeating the above procedure. Make additional adjustments as necessary until a check results in a momentary pick-up of approximately 50 RPM. Each time the adjustment is changed, the engine should be run up to 2000 RPM to clean the engine before proceeding with the RPM check. Make final adjustment of the idle speed adjustment to obtain the desired idling RPM with closed throttle. The above method aims at a setting that will obtain maximum RPM with minimum manifold pressure. In case the setting does not remain stable, check the idle linkage; any looseness in this linkage would cause erratic idling. In all cases, allowance should be made for the effect of weather conditions and field altitude upon idling adjustment.

3. LUBRICATION SYSTEM.

- a. *Oil Grades and Limitations* – Service the engine in accordance with the recommended grade oil as specified in Section 3, Item 8.
- b. *Oil Suction and Oil Pressure Screens* – At each 100-hour inspection remove suction screen. Inspect for metal particles; clean and reinstall. Inspect and clean pressure screen every 25 hours.
- c. *Oil Pressure Relief Valve* – Subject engines may be equipped with either an adjustable or non-adjustable oil pressure relief valve. A brief description of both types follows:
 - (1) *Non-Adjustable Oil Pressure Relief Valve* – The function of the oil pressure relief valve is to maintain engine oil pressure within specified limits. The valve, although not adjustable, may control the oil pressure with the addition of a maximum of nine (9) P/N STD-425 washers between the cap and spring to increase the pressure. Removal of the washers will decrease the oil pressure. Some early model engines use a maximum of three (3) P/N STD-425 washers to increase the oil pressure and the use of a P/N 73629 or P/N 73630 spacer between the cap and crankcase to decrease the oil pressure. Particles of metal or other foreign matter lodged between the ball and seal will result in faulty readings. It is advisable, therefore, to disassemble, inspect and clean the valve if excessive pressure fluctuations are noted.
 - (2) *Oil Pressure Relief Valve (Adjustable)* – The adjustable oil relief valve enables the operator to maintain engine oil pressure within the specified limits. If pressure under normal operating conditions should consistently exceed the maximum or minimum specified limits, adjust the valve as follows:

With the engine warmed up and running at approximately 2000 RPM, observe the reading on the oil pressure gage. If the pressure is above maximum or below minimum specified limits, stop engine and screw the adjusting screw outward to decrease pressure or inward to increase pressure. Depending on installation, the adjusting screw may have only a screw driver slot and is turned with a screw driver; or may have the screw driver slot plus a pinned .375-24 castellated nut and may be turned with either a screw driver or a box wrench.

4. *CYLINDERS*. It is recommended that as a field operation, cylinder maintenance be confined to replacement of the entire assembly. For valve replacement, consult the proper overhaul manual. This should be undertaken only as an emergency measure.

**SECTION 5
MAINTENANCE PROCEDURES**

**LYCOMING OPERATOR'S MANUAL
O-360 AND ASSOCIATED MODELS**

a. Removal of Cylinder Assembly.

- (1) Remove exhaust manifold.
- (2) Remove rocker box drain tube, intake pipe, baffle and any clips that might interfere with the removal of the cylinder.
- (3) Disconnect ignition cables and remove the bottom spark plug.
- (4) Remove rocker box cover and rotate crankshaft until piston is approximately at top center of the compression stroke. This is indicated by a positive pressure inside of cylinder tending to push thumb off of bottom spark plug hole.
- (5) Slide valve rocker shafts from cylinder head and remove the valve rockers. Valve rocker shafts can be removed when the cylinder is removed from the engine. Remove rotator cap from exhaust valve stem.
- (6) Remove push rods by grasping ball end and pulling rod out of shroud tube. Detach shroud tube spring and lock plate and pull shroud tubes through holes in cylinder head.

NOTE

The hydraulic tappets, push rods, rocker arms and valves must be assembled in the same location from which they were removed.

- (7) Remove cylinder base nuts and hold down plates (where employed) then remove cylinder by pulling directly away from crankcase. Be careful not to allow the piston to drop against the crankcase, as the piston leaves the cylinder.
- b. Removal of Piston from Connecting Rod* – Remove the piston pin plugs. Insert piston pin puller through piston pin, assemble puller nut; then proceed to remove piston pin. Do not allow connecting rod to rest on the cylinder bore of the crankcase. Support the connecting rod with heavy rubber band, discarded cylinder base oil ring seal, or any other non-marring method.
- c. Removal of Hydraulic Tappet Sockets and Plunger Assemblies* – It will be necessary to remove and bleed the hydraulic tappet plunger assembly so that dry tappet clearance can be checked when the cylinder assembly is reinstalled. This is accomplished in the following manner:
- (1) Remove the hydraulic tappet push rod socket by inserting the forefinger into the concave end of the socket and withdrawing. If the socket cannot be removed in this manner, it may be removed by grasping the edge of the socket with a pair of needle nose pliers. However, care must be exercised to avoid scratching the socket.
 - (2) To remove the hydraulic tappet plunger assembly, use the special Lycoming service tool. In the event the tool is not available, the hydraulic tappet plunger assembly may be removed by a hook in the end of a short piece of lockwire, inserting the wire so that the hook engages the spring of the plunger assembly. Draw the plunger assembly out of the tappet body by gently pulling the wire.

CAUTION

NEVER USE A MAGNET TO REMOVE HYDRAULIC PLUNGER ASSEMBLIES FROM THE CRANKCASE. THIS CAN CAUSE THE CHECK BALL TO REMAIN OFF ITS SEAT, RENDERING THE UNIT INOPERATIVE.

- d. *Assembly of Hydraulic Tappet Plunger Assemblies* – To assemble the unit, unseat the ball by inserting a thin clean wire through the oil inlet hole. With the ball off its seat, insert the plunger and twist clockwise so that the spring catches. All oil must be removed before the plunger is inserted.
- e. *Assembly of Cylinder and Related Parts* – Rotate the crankshaft so that the connecting rod of the cylinder being assembled is at the top center of compression stroke. This can be checked by placing two fingers on the intake and exhaust tappet bodies. Rock crankshaft back and forth over top center. If the tappet bodies do not move the crankshaft is on the compression stroke.
- (1) Place each plunger assembly in its respective tappet body and assemble the socket on top of plunger assembly.
 - (2) Assemble piston with rings so that the number stamped on the piston pin boss is toward the front of the engine. The piston pin should be a handpush fit. If difficulty is experienced in inserting the piston pin, it is probably caused by carbon or burrs in the piston pin hole. During assembly, always use a generous quantity of oil, both in the piston hole and on the piston pin.
 - (3) Assemble one piston pin plug at each end of the piston pin and place a new rubber oil seal ring around the cylinder skirt. Coat piston and rings and the inside of the cylinder generously with oil.
 - (4) Using a piston ring compressor, assemble the cylinder over the piston so that the intake port is at the bottom of the engine. Push the cylinder all the way on, catching the ring compressor as it is pushed off.

NOTE

Before installing cylinder hold-down nuts, lubricate crankcase thru-stud threads with any one of the following lubricants, or combination of lubricants

1. 90% SAE 50W engine oil and 10% STP.
 2. Parker Thread Lube.
 3. 60% SAE 30 engine oil and 40% Parker Thread Lube.
- (5) Assemble hold-down plates (where applicable) and cylinder base hold-down nuts and tighten as directed in the following steps.

NOTE

At any time a cylinder is replaced, it is necessary to retorque the thru-studs on the cylinder on the opposite side of the engine.

- (a) *(Engines using hold-down plates)* – Install shims between cylinder base hold-down plates and cylinder barrel, as directed in Figure 5-3, and tighten ½ inch hold-down nuts to 300 in.-lbs. (25 ft.-lbs.) torque, using the sequence shown in Figure 5-3.

**SECTION 5
MAINTENANCE PROCEDURES**

**LYCOMING OPERATOR'S MANUAL
O-360 AND ASSOCIATED MODELS**

- (b) Remove shims, and using the same sequence, tighten the ½ inch cylinder base nuts to 600 in.-lbs. (50 ft.-lbs.) torque.

NOTE

Cylinder assemblies not using hold-down plate are tightened in the same manner as above omitting the shims.

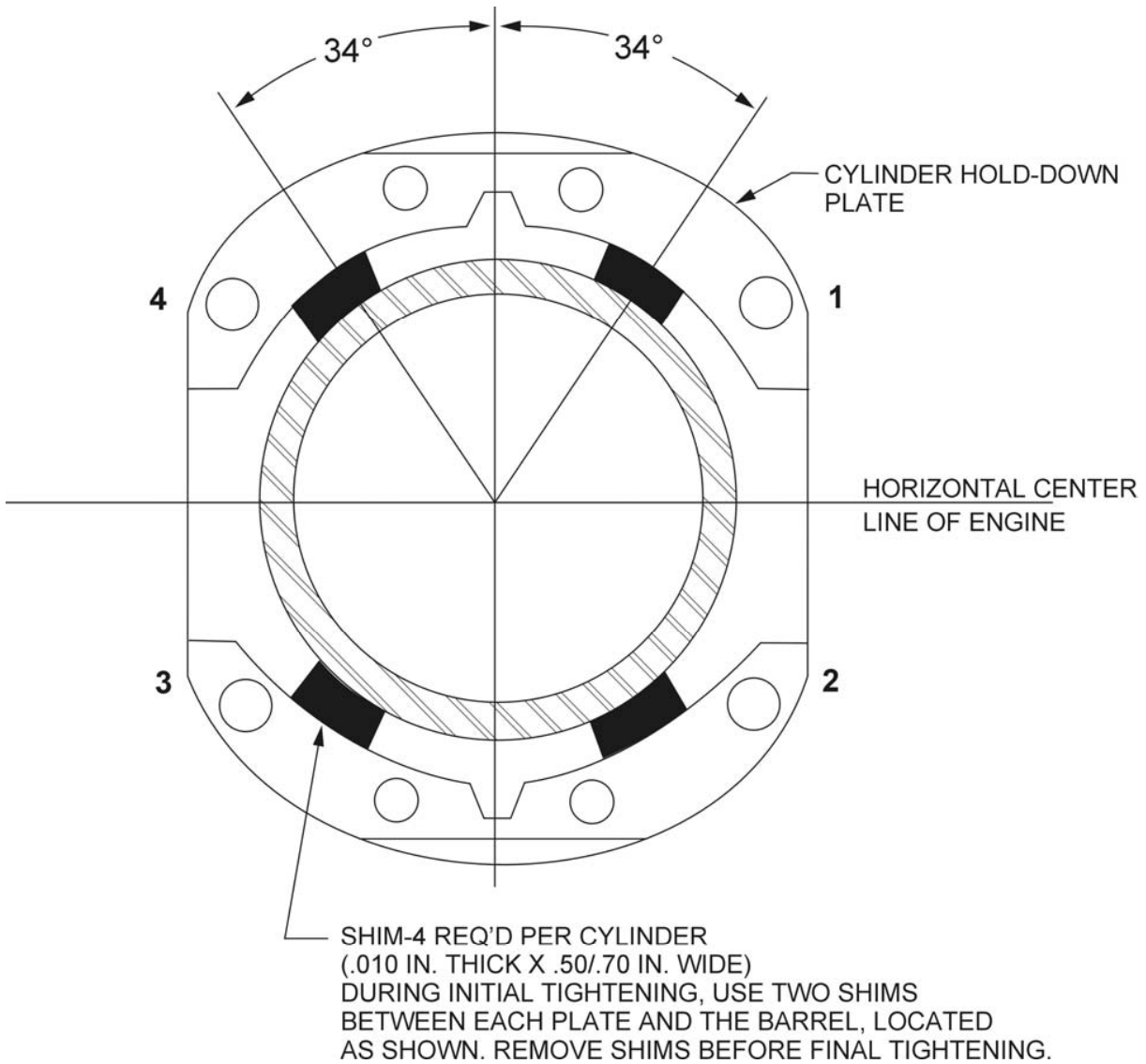

Figure 5-3. Location of Shims Between Cylinder Barrel and Hold-Down Plates (where applicable) and Sequence of Tightening Cylinder Base Hold-Down Nuts

- (c) Tighten the $\frac{3}{8}$ inch hold-down nuts to 300 in.-lbs. (25 ft.-lbs.) torque. Sequence of tightening is optional.
- (d) As a final check, hold the torque wrench on each nut for about five seconds. If the nut does not turn, it may be presumed to be tightened to correct torque.

CAUTION

AFTER ALL CYLINDER BASE NUTS HAVE BEEN TIGHTENED, REMOVE ANY NICKS IN THE CYLINDER FINS BY FILING OR BURRING.

- (6) Install new shroud tube oil seals on both ends of shroud tube. Install shroud tube and lock in place as required for type of cylinder.
- (7) Assemble each push rod in its respective shroud tube, and assemble each rocker in its respective position by placing rocker between bosses and sliding valve rocker shaft in place to retain rocker. Before installing exhaust valve rocker, place rotator cap over end of exhaust valve stem.
- (8) Be sure that the piston is at top center of compression stroke and that both valves are closed. Check clearance between the valve stem tip and the valve rocker. In order to check this clearance, place the thumb of one hand on the valve rocker directly over the end of the push rod and push down so as to compress the hydraulic tappet spring. While holding the spring compressed, the valve clearance should be between .028 and .080 inch. If clearance does not come within these limits, remove the push rod and insert a longer or shorter push rod, as required, to correct clearance.

NOTE

Inserting a longer push rod will decrease the valve clearance.

- (9) Install intercylinder baffles, rocker box covers, intake pipes, rocker box drain tubes and exhaust manifold.

5. GENERATOR OR ALTERNATOR DRIVE BELT TENSION.

Check the tension of a new belt 25 hours after installation. Refer to latest revision of Service Instruction No. 1129 and latest revision of Service Letter No. L160 for methods of checking generator or alternator drive belt tension.

6. TURBOCHARGER CONTROLS.

- a. *Density Controller* – The density controller is adjusted at the factory to maintain a predetermined constant for desired horsepower.

The density controller is set to the curve, see Figure 5-4, under the following conditions: Engine stabilized at operating conditions, full throttle with oil pressure at 80 psi \pm 5 psi.

If it is suspected that the manifold pressure is not within limits, it may be checked to the curve.

EXAMPLE

Operating at the stated conditions with a compressor discharge temperature of 120°F, the manifold pressure should be 34.8 in. Hg. \pm .3 in. Hg.

SECTION 5
MAINTENANCE PROCEDURES

LYCOMING OPERATOR'S MANUAL
O-360 AND ASSOCIATED MODELS

If the manifold pressure is found to be out of limits, the cause might be found either in the density controller, the differential pressure controller, or the waste gate. It is recommended that an authorized overhaul facility check these controls.

Exhaust Bypass Valve (TIO-360-A Series).

This valve is actuated by engine oil pressure and is set to predetermined open and closed clearances. These clearances and the procedures for setting them are shown in Figure 5-5.

Exhaust Bypass Valve (TIO-360-C1A6D).

This valve is mechanically controlled by a flexible linkage connected to the injector throttle arm and the wastegate control arm.

Adjust linkage as follows:

- (1) Move injector throttle arm to full open position.
- (2) Insert a .005-.015 inch feeler gage between the bypass butterfly valve, in the closed position, and the bypass housing.
- (3) Adjust linkage until the bypass valve control arm is at the full closed stop position.

C-13104

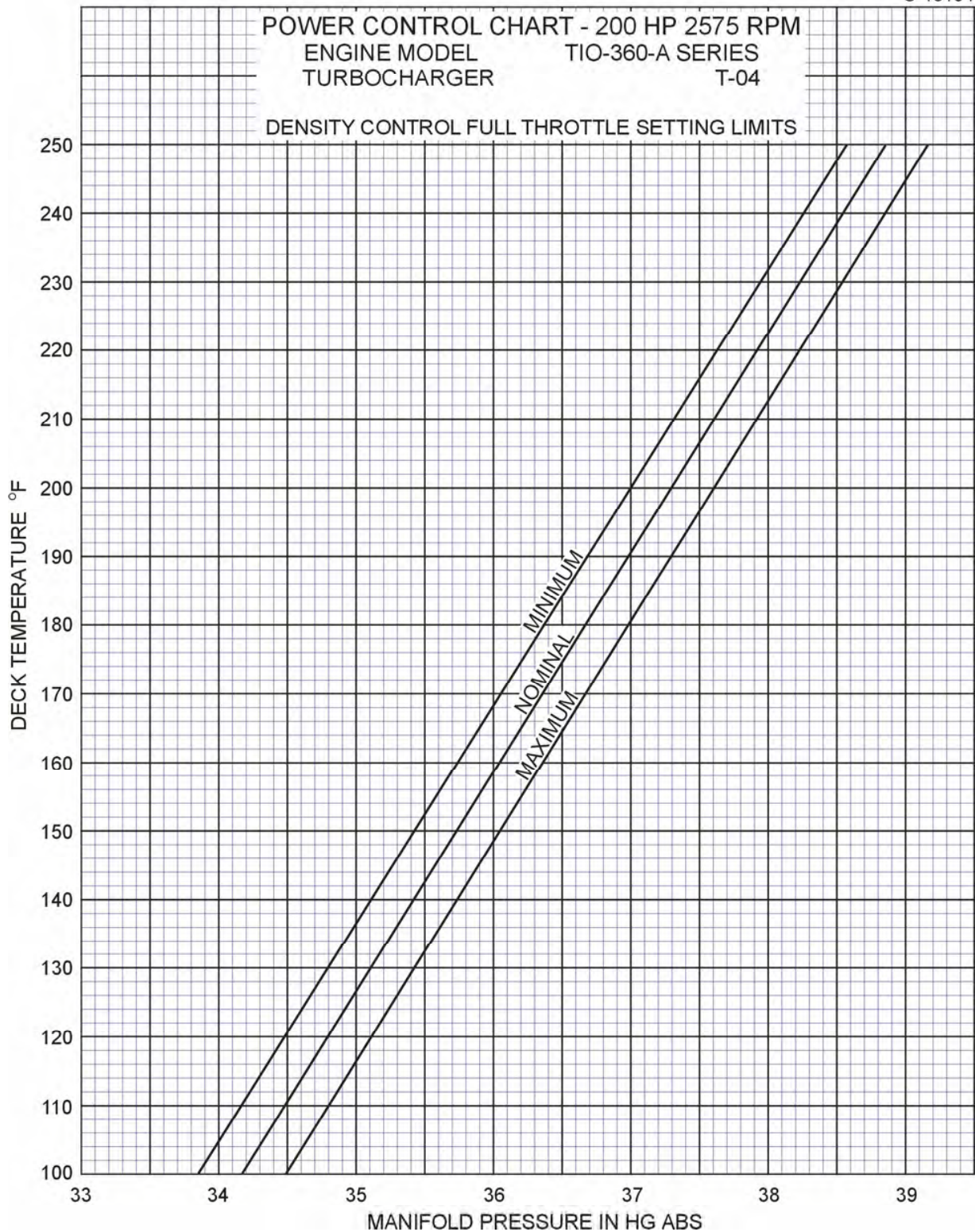

Figure 5-4. Density Control Full Throttle Setting Limits

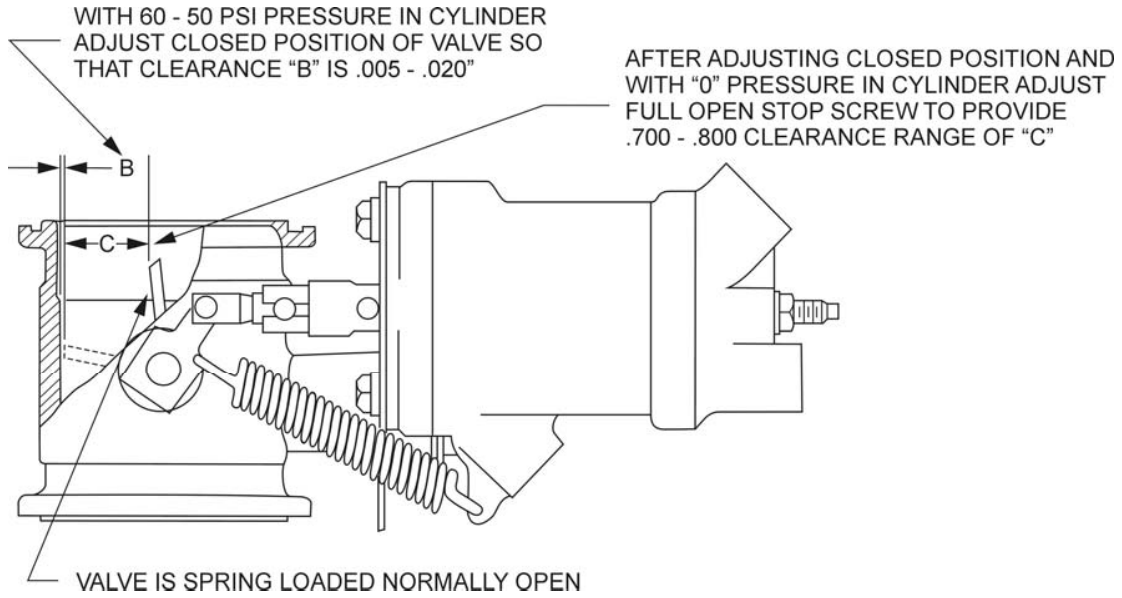

Figure 5-5. Exhaust Bypass Valve Open and Closed Setting

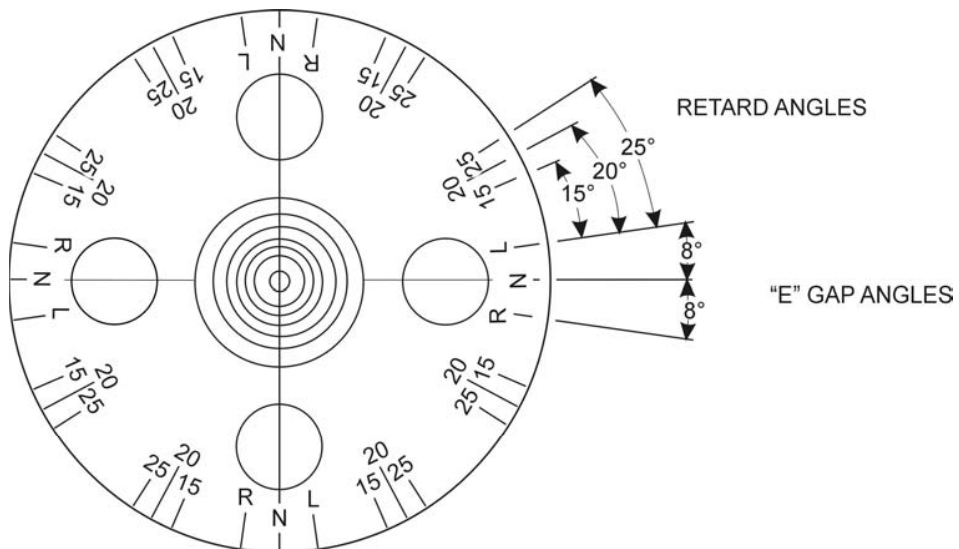

Figure 5-6. Timing Marks on Rotating Magnet

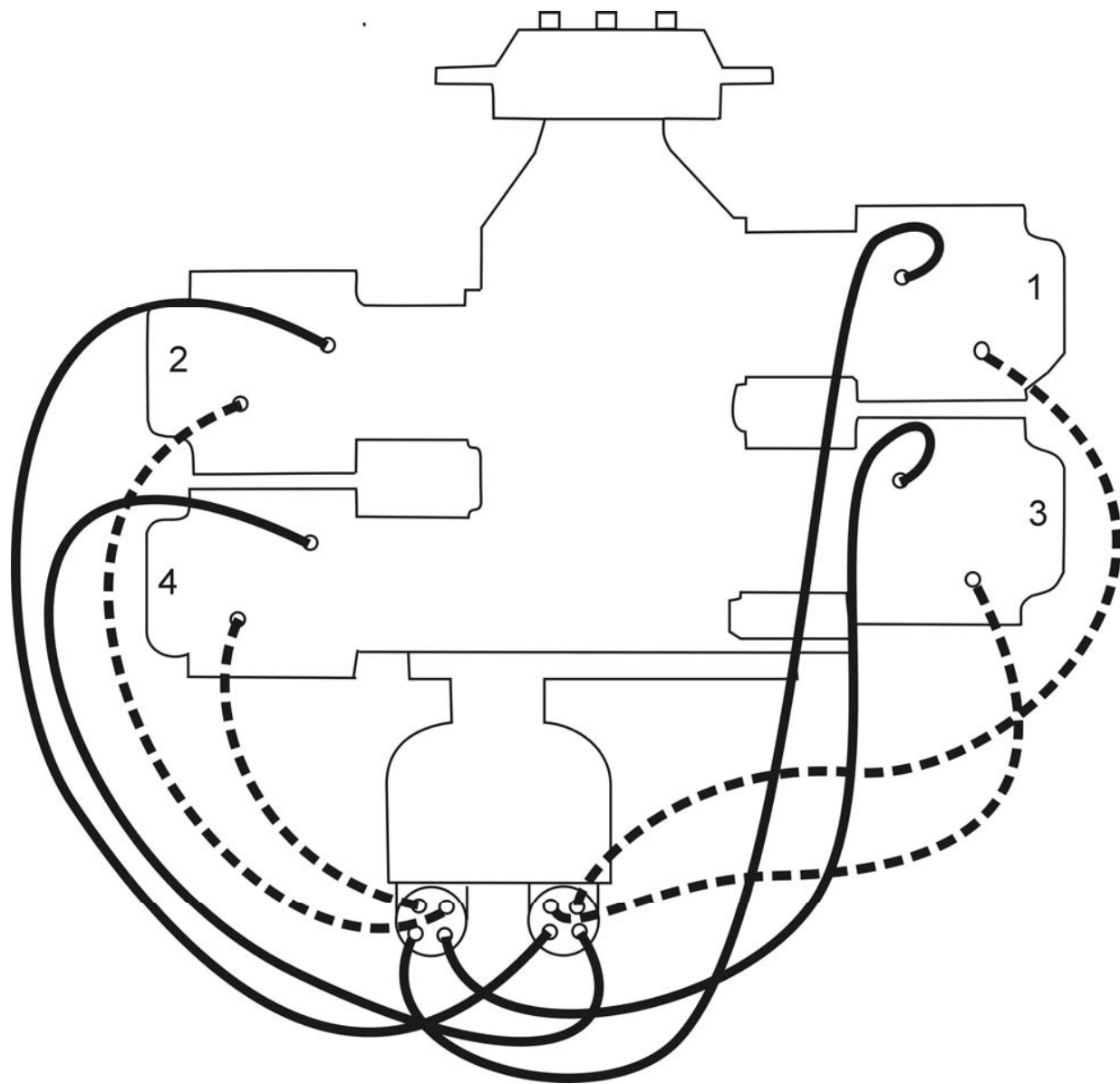

Figure 5-7. Ignition Wiring Diagram, Dual Magneto

This Page Intentionally Left Blank

LYCOMING OPERATOR'S MANUAL

SECTION 6 TROUBLE-SHOOTING – ENGINE

	Page
Failure of Engine to Start.....	6-1
Failure of Engine to Idle Properly.....	6-2
Low Power and Uneven Running.....	6-2
Failure of Engine to Develop Full Power	6-3
Rough Engine	6-3
Low Oil Pressure.....	6-3
High Oil Temperature	6-3
Excessive Oil Consumption.....	6-4

TROUBLE-SHOOTING – TURBOCHARGER

Excessive Noise or Vibration.....	6-4
Engine Will Not Deliver Rated Power	6-4
Critical Altitude Lower Than Specified.....	6-5
Engine Surges or Smokes	6-6
High Deck Pressure.....	6-6

This Page Intentionally Left Blank

SECTION 6

TROUBLE-SHOOTING

Experience has proven that the best method of trouble-shooting is to decide on the various causes of a given trouble and then to eliminate causes one by one, beginning with the most probable. The following charts list some of the more common troubles, which may be encountered in maintaining engines and turbochargers; their probable causes and remedies.

1. TROUBLE-SHOOTING – ENGINE.

TROUBLE	PROBABLE CAUSE	REMEDY
Failure of Engine to Start	Lack of fuel	Check fuel system for leaks. Fill fuel tank. Clean dirty lines, strainers, or fuel valves.
	Overpriming	Leave ignition "off" and mixture control in "Idle Cut-Off", open throttle and "unload" engine by cranking for a few seconds. Turn ignition switch on and proceed to start in a normal manner.
	Defective spark plugs	Clean and adjust or replace spark plugs.
	Defective ignition wire	Check with electric tester, and replace any defective wires.
	Defective battery	Replace with charged battery.
	Improper operation of magneto breaker	Clean points. Check internal timing of magnetos.
	Lack of sufficient fuel flow	Disconnect fuel line and check fuel flow.
	Water in fuel injector or carb.	Drain fuel injector or carburetor and fuel lines.
	Internal failure	Check oil screens for metal particles. If found, complete overhaul of the engine may be indicated.

**SECTION 6
TROUBLE-SHOOTING**

**LYCOMING OPERATOR'S MANUAL
O-360 AND ASSOCIATED MODELS**

TROUBLE	PROBABLE CAUSE	REMEDY
Failure of Engine to Idle Properly	Incorrect idle mixture	Adjust mixture.
	Leak in the induction system	Tighten all connections in the induction system. Replace any parts that are defective.
	Incorrect idle mixture	Adjust throttle stop to obtain correct idle.
	Uneven cylinder compression	Check condition of piston rings and valve seats.
	Faulty ignition system	Check entire ignition system.
Low Power and Uneven Running	Insufficient fuel pressure	Adjust fuel pressure.
	Mixture too rich indicated by sluggish engine operation, red exhaust flame at night. Extreme cases indicated by black smoke from exhaust.	Readjustment of fuel injector or carburetor by authorized personnel is indicated.
	Mixture too lean indicated by overheating or backfiring	Check fuel lines for dirt or other restrictions. Readjustment of fuel injector or carburetor by authorized personnel is indicated.
	Leaks in induction system	Tighten all connections. Replace defective parts.
	Defective spark plugs	Clean and gap or replace spark plugs.
	Improper fuel	Fill tank with fuel of recommended grade.
	Magneto breaker points not working properly	Clean points. Check internal timing of magnetos.
	Defective ignition wire	Check wire with electric tester. Replace defective wire.
	Defective spark plug terminal connectors	Replace connectors on spark plug wire.

TROUBLE	PROBABLE CAUSE	REMEDY
Failure of Engine to Develop Full Power	Leak in the induction system	Tighten all connections and replace defective parts.
	Throttle lever out of adjustment	Adjust throttle lever.
	Improper fuel flow	Check strainer, gage and flow at the fuel inlet.
	Restriction in air scoop	Examine air scoop and remove restrictions.
	Improper fuel	Drain and refill tank with recommended fuel.
Rough Engine	Faulty ignition	Tighten all connections. Check system with tester. Check ignition timing.
	Cracked engine mount	Replace or repair mount.
	Defective mounting bushings	Install new mounting bushings.
Low Oil Pressure	Uneven compression	Check compression.
	Insufficient oil	Fill to proper level with recommended oil.
	Air lock or dirt in relief valve	Remove and clean oil pressure relief valve.
	Leak in suction line or pressure line	Check gasket between accessory housing and crankcase.
	High oil temperature	See "High Oil Temperature" in "Trouble" column.
	Defective pressure gage	Replace.
	Stoppage in oil pump intake passage	Check line for obstruction. Clean suction strainer.
High Oil Temperature	Insufficient air cooling	Check air inlet and outlet for deformation or obstruction.
	Insufficient oil supply	Fill to proper level with specified oil.

**SECTION 6
TROUBLE-SHOOTING**

**LYCOMING OPERATOR'S MANUAL
O-360 AND ASSOCIATED MODELS**

TROUBLE	PROBABLE CAUSE	REMEDY
High Oil Temperature (Cont.)	Low grade of oil	Replace with oil conforming to specifications.
	Clogged oil lines or strainers	Remove and clean oil strainers.
	Excessive blow-by	Usually caused by worn or stuck rings.
	Defective temperature gage	Replace gage.
Excessive Oil Consumption	Low grade of oil	Fill tank with oil conforming to specifications.
	Failing or failed bearings	Check sump for metal particles.
	Worn piston rings	Install new rings.
	Incorrect installation of piston rings	Install new rings.
	Failure of rings to seat (new nitrided cylinders)	Use mineral base oil. Climb to cruise altitude at full power and operate at 75% cruise power setting until oil consumption stabilizes.

2. TROUBLE-SHOOTING – TURBOCHARGER.

TROUBLE	PROBABLE CAUSE	REMEDY
Excessive Noise or Vibration	Improper bearing lubrication	Supply required oil pressure. Clean or replace oil line; clean oil strainer. If trouble persists, overhaul turbocharger.
	Leak in engine intake or exhaust manifold	Tighten loose connections or replace manifold gaskets as necessary.
	Dirty impeller blades	Disassemble and clean.
Engine Will Not Deliver Rated Power	Clogged manifold system	Clear all ducting.
	Foreign material lodged in compressor impeller or turbine	Disassemble and clean.

TROUBLE	PROBABLE CAUSE	REMEDY	
Engine Will Not Deliver Rated Power (Cont.)	Excessive dirt build-up in compressor	Thoroughly clean compressor assembly. Service air cleaner and check for leakage.	
	Rotating assembly bearing seizure	Overhaul turbocharger.	
	Restrictions in return lines from actuator to waste gate controller	Remove and clean lines.	
	Exhaust bypass controller is in need of adjustment	Have exhaust bypass controller adjusted.	
	Oil pressure too low	Tighten fittings. Replace lines or hoses. Increase oil pressure to desired pressure.	
	Inlet orifice to actuator clogged	Remove inlet line at actuator and clean orifice.	
	Exhaust bypass controller malfunction	Replace unit.	
	Exhaust bypass butterfly not closing	Low pressure. Clogged orifice in inlet to actuator.	
		Butterfly shaft binding. Check bearings.	
	Turbocharger impeller binding, frozen or fouling housing	Check bearings. Replace turbocharger.	
Piston seal in actuator leaking. (Usually accompanied by oil leakage at drain line.)	Remove and replace actuator or disassemble and replace packing.		
Critical Altitude Lower Than Specified	Controller not getting enough oil pressure to close the waste gate	Check pump outlet pressure, oil filters, external lines for leaks or obstructions.	
	Chips under metering valve in controller holding it open	Replace controller.	
	Metering jet in actuator plugged	Remove actuator and clean jet.	
	Actuator piston seal failed and leaking excessively	If there is oil leakage at actuator drain, clean cylinder and replace piston seal.	

**SECTION 6
TROUBLE-SHOOTING**

**LYCOMING OPERATOR'S MANUAL
O-360 AND ASSOCIATED MODELS**

TROUBLE	PROBABLE CAUSE	REMEDY
Critical Altitude Lower Than Specified (Cont.)	Exhaust bypass valve sticking	Clean and free action.
Engine Surges or Smokes	Air in oil lines or actuator	Bleed system.
	Controller metering valve stem seal leaking oil into manifold	Replace controller.
	Clogged breather	Check breather for restrictions to air flow.
<i>NOTE</i>		
<i>Smoke would be normal if engine has idled for a prolonged period.</i>		
High Deck Pressure (Compressor Discharge Pressure)	Controller metering valve not opening, aneroid bellows leaking	Replace controller assembly or replace aneroid bellows.
	Exhaust bypass sticking closed	Shut off valve in return line not working.
		Butterfly shaft binding. Check bearings.
		Replace bypass valve or correct linkage binding.
	Controller return line restricted	Clean or replace line.
	Oil pressure too high	Check pressure 75 to 85 psi (80 psi desired) at exhaust bypass actuator desired.
If pressure on outlet side of actuator is too high, have exhaust bypass controller adjusted.		
Exhaust bypass actuator piston locked in full closed position. (Usually accompanied by oil leakage at actuator drain line.) NOTE: Exhaust bypass normally closed in idle and low power condition. Should open when actuator inlet line is disconnected.	Remove and disassemble actuator, check condition of piston and packing or replace actuator assembly.	
	Exhaust bypass controller malfunction	Replace controller.

LYCOMING OPERATOR'S MANUAL

SECTION 7 INSTALLATION AND STORAGE

	Page
Preparation of Engine for Installation.....	7-1
General.....	7-1
Inspection of Engine Mounting	7-1
Attaching Engine to Mounts	7-1
Oil and Fuel Line Connections	7-1
Propeller Installation	7-2
Preparation of Carburetors and Fuel Injectors for Installation	7-2
Corrosion Prevention in Engines Installed in Inactive Aircraft.....	7-2

This Page Intentionally Left Blank

SECTION 7

INSTALLATION AND STORAGE

1. PREPARATION OF ENGINE FOR INSTALLATION. Before installing an engine that has been prepared for storage, remove all dehydrator plugs, bags of desiccant and preservative oil from the engine. Preservative oil can be removed by removing the bottom spark plugs and turning the crankshaft three or four revolutions by hand. The preservative oil will then drain through the spark plug holes. Draining will be facilitated if the engine is tilted from side to side during the above operation. Preservative oil which has accumulated in the sump can be drained by removing the oil sump plug. Engines that have been stored in a cold place should be removed to an environment of at least 70°F (21°C) for a period of 24 hours before preservative oil is drained from the cylinders. If this is not possible, heat the cylinders with heat lamps before attempting to drain the engine.

After the oil sump has been drained, the plug should be replaced and safety-wired. Fill the sump or external tank with lubricating oil. The crankshaft should again be turned several revolutions to saturate the interior of the engine with the clean oil. When installing spark plugs, make sure that they are clean, if not, wash them in clean petroleum solvent. Of course, there will be a small amount of preservative oil remaining in the engine, but this can cause no harm. However, after twenty-five hours of operation, the lubricating oil should be drained while the engine is hot. This will remove any residual preservative oil that may have been present.

CAUTION

DO NOT ROTATE THE CRANKSHAFT OF AN ENGINE CONTAINING PRESERVATIVE OIL BEFORE REMOVING THE SPARK PLUGS, BECAUSE IF THE CYLINDERS CONTAIN ANY APPRECIABLE AMOUNT OF THE MIXTURE, THE RESULTING ACTION, KNOWN AS HYDRAULICING, WILL CAUSE DAMAGE TO THE ENGINE. ALSO, ANY CONTACT OF THE PRESERVATIVE OIL WITH PAINTED SURFACES SHOULD BE AVOIDED.

General – Should any of the dehydrator plugs, containing crystals of silica-gel or similar material, be broken during their term of storage or upon their removal from the engine, and if any of the contents should fall into the engine, that portion of the engine must be disassembled and thoroughly cleaned before using the engine. The oil strainers should be removed and cleaned in gasoline or some other hydrocarbon solvent. The fuel drain screen located in the fuel inlet of the carburetor or fuel injector should also be removed and cleaned in a hydrocarbon solvent. The operator should also note if any valves are sticking. If they are, this condition can be eliminated by coating the valve stem generously with a mixture of gasoline and lubrication oil.

Inspection of Engine Mounting – If the aircraft is one from which an engine has been removed, make sure that the engine mount is not bent or damaged by distortion or misalignment as this can produce abnormal stresses with the engine.

Attaching Engine to Mounts – See airframe manufacturer's recommendations for method of mounting the engine.

Oil and Fuel Line Connections – The oil and fuel line connections are called out on the accompanying installation drawings.

**SECTION 7
INSTALLATION AND STORAGE**

**LYCOMING OPERATOR'S MANUAL
O-360 AND ASSOCIATED MODELS**

Propeller Installation – Consult the airframe manufacturer for information relative to propeller installation.

1. PREPARATION OF CARBURETORS AND FUEL INJECTORS FOR INSTALLATION.

Carburetors and fuel injectors that have been prepared for storage should undergo the following procedures before being placed in service.

Carburetor (MA-4-5, MA-4-5AA) – Remove the fuel drain plug and drain preservative oil. Remove the fuel inlet strainer assembly and clean in a hydrocarbon solvent. Reinstall the fuel drain plug and fuel inlet strainer assembly.

Carburetor (PSH-5BD) – Remove the fuel inlet strainer and all plugs leading to the fuel chambers. Drain preservative oil from the carburetor. Clean the fuel inlet strainer in a hydrocarbon solvent. Reinstall fuel inlet strainer and replace all plugs.

Remove plug opposite the manual mixture control needle and drain any accumulated moisture from the air chamber. Replace plug.

With the throttle lever in the wide open position and the manual mixture control in the full rich position, inject clean fuel through the fuel inlet connection at 5 psi until clean fuel flows from the discharge nozzle.

CAUTION

DO NOT ALLOW FUEL OR OIL TO ENTER INTO THE AIR CHAMBER.

Move the throttle lever to the closed position and the mixture control lever to the idle cut-off position. Because this carburetor has a closed fuel system, it will remain full of fuel as long as the mixture control lever is in the idle cut-off position.

NOTE

It is necessary that this carburetor soak for an eight hour period before starting the engine. The soaking period may be performed prior to or after installation on the engine.

Fuel Injector (Bendix) – Remove and clean the fuel inlet strainer assembly and reinstall. Inject clean fuel into the fuel inlet connection with the fuel outlets uncapped until clean fuel flow from the outlets. Do not exceed 15 psi inlet pressure.

CORROSION PREVENTION IN ENGINES INSTALLED IN INACTIVE AIRCRAFT

Corrosion can occur, especially in new or overhauled engines, on cylinder walls of engines that will be inoperative for periods as brief as two days. Therefore, the following preservation procedure is recommended for inactive engines and will be effective in minimizing the corrosion condition for a period up to thirty days.

NOTE

Ground running the engine for brief periods of time is not a substitute for the following procedure; in fact, the practice of ground running will tend to aggravate rather than minimize this corrosion condition

- a. As soon as possible after the engine is stopped, move the aircraft into the hangar, or other shelter where the preservation process is to be performed.
- b. Remove sufficient cowling to gain access to the spark plugs and remove both spark plugs from each cylinder.
- c. Spray the interior of each cylinder with approximately two (2) ounces of corrosion preventive oil while cranking the engine about five (5) revolutions with the starter. The spray gun nozzle may be placed in either of the spark plug holes.

NOTE

Spraying should be accomplished using an airless spray gun (Spraying Systems Co., "Gunjet" Model 24A-8395 or equivalent). In the event an airless spray gun is not available, personnel should install a moisture trap in the air line of a conventional spray gun and be certain oil is hot at the nozzle before spraying cylinders.

- d. With the crankshaft stationary, again spray each cylinder through the spark plug holes with approximately two (2) ounces of corrosion preventive oil. Assemble spark plugs and do not turn crankshaft after cylinders have been sprayed.

The corrosion preventive oil to be used in the foregoing procedure should conform to specification MIL-L-6529, Type 1, heated to 200°F/220°F (93°C/104°C) spray nozzle temperature. It is not necessary to flush preservative oil from the cylinder prior to flying the aircraft. The small quantity of oil coating the cylinders will be expelled from the engine during the first few minutes of operation.

NOTE

Oils of the type mentioned are to be used in Lycoming aircraft engines for corrosion prevention only, and not for lubrication. See the latest revision of Lycoming Service Instruction No. 1014 and latest revision of Service Bulletin No. 318 for recommended lubricating oil.

**SECTION 7
INSTALLATION AND STORAGE**

**LYCOMING OPERATOR'S MANUAL
O-360 AND ASSOCIATED MODELS**

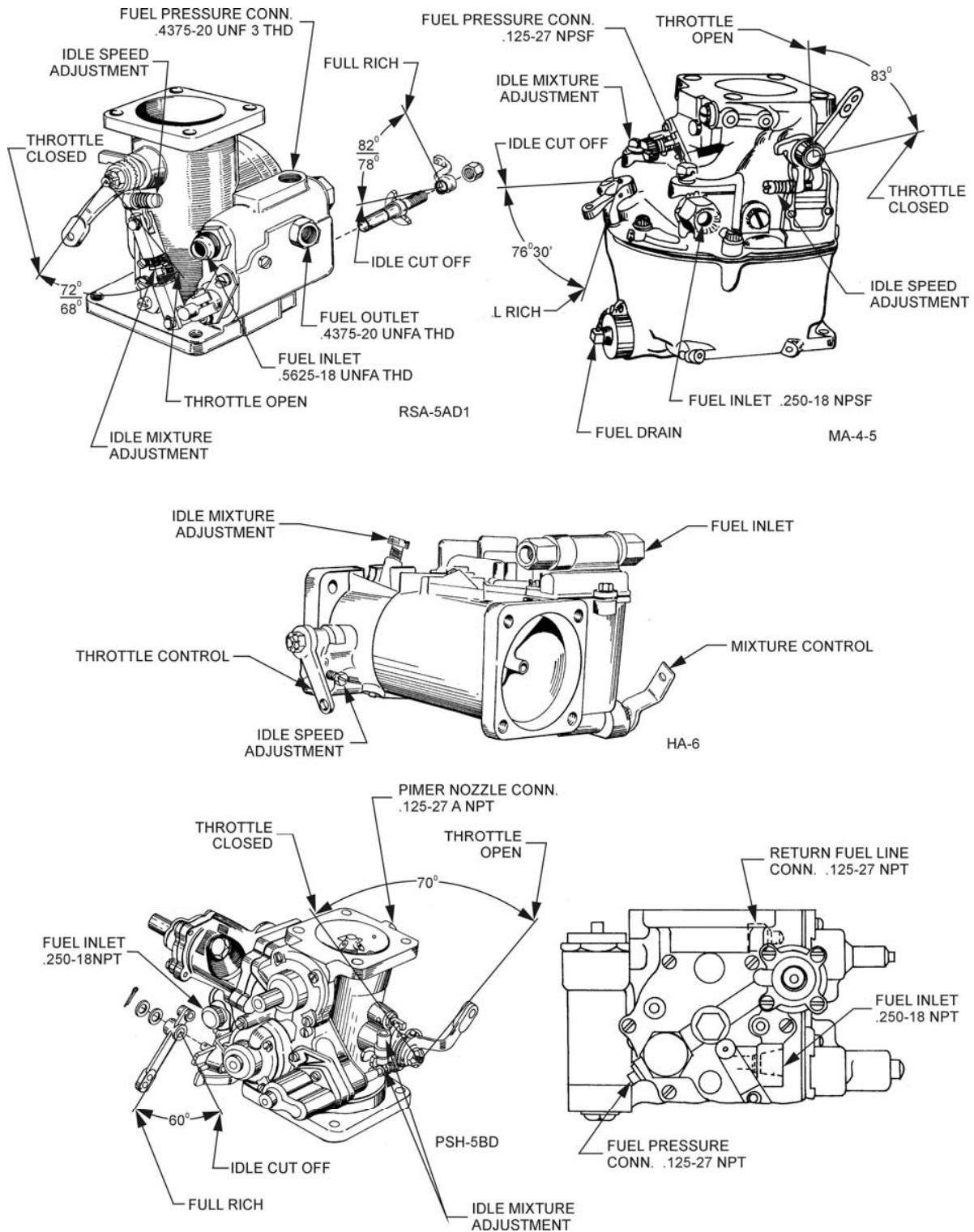

Figure 7-1. Fuel Metering System

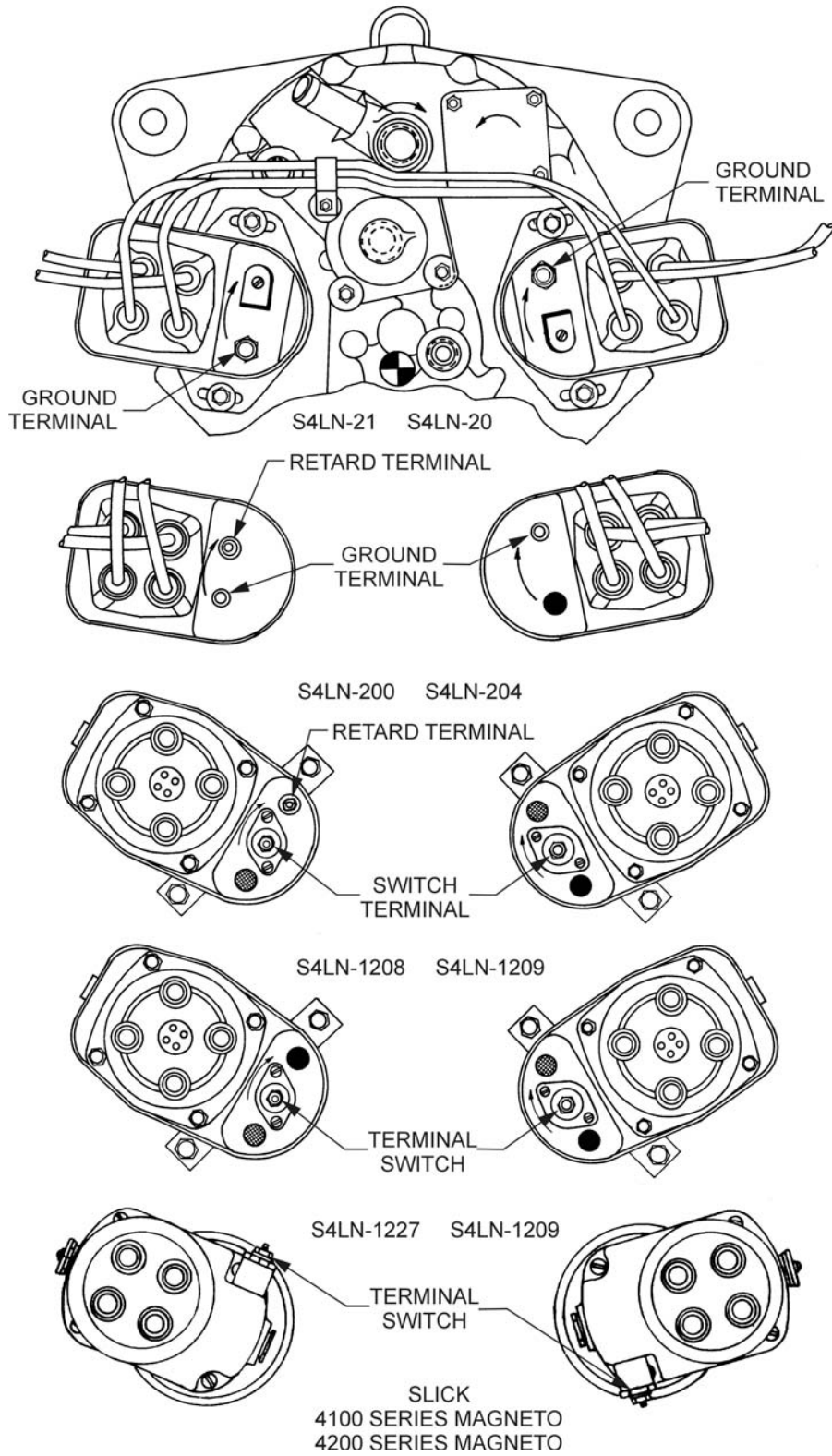

Figure 7-2. Magneto Connections

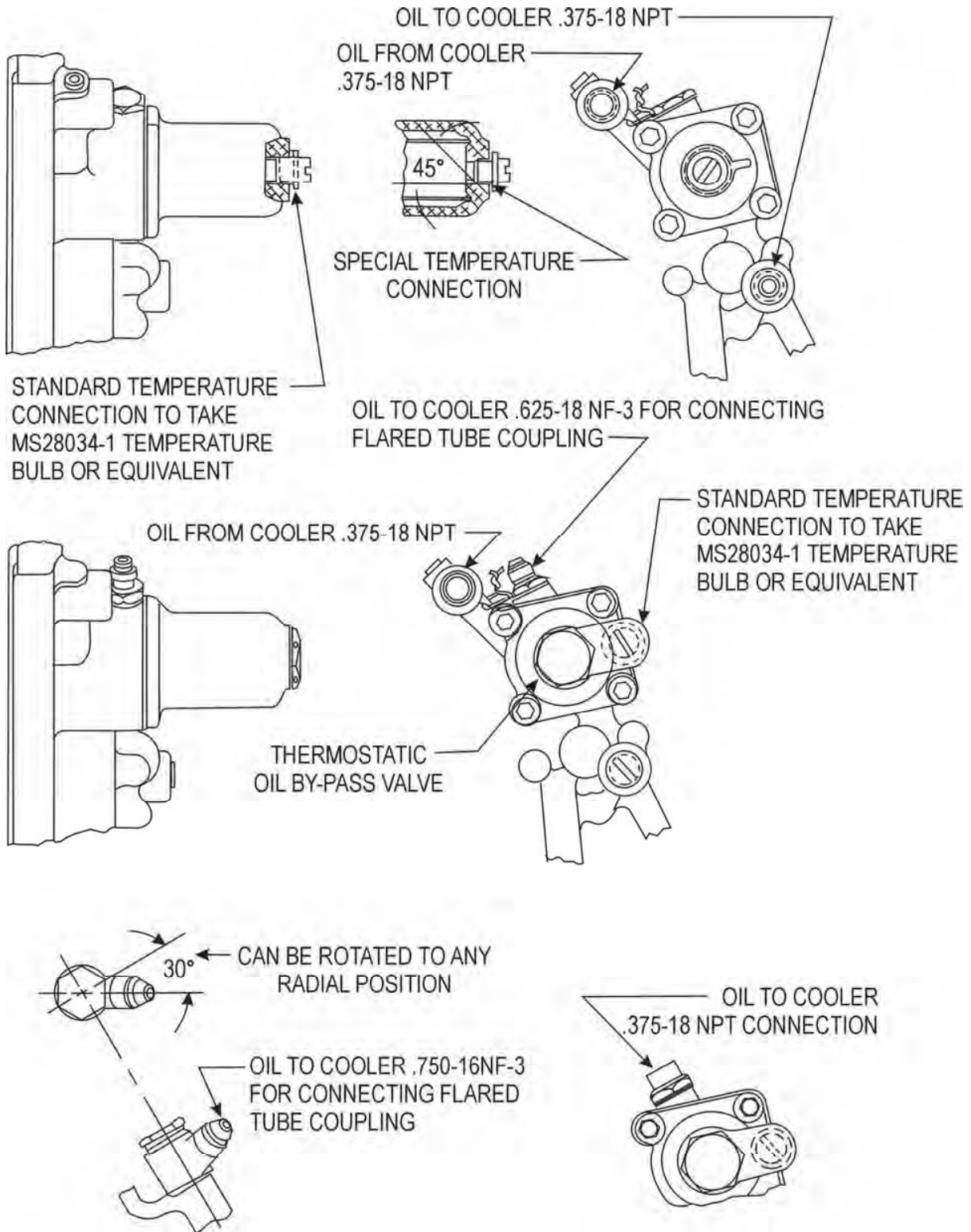
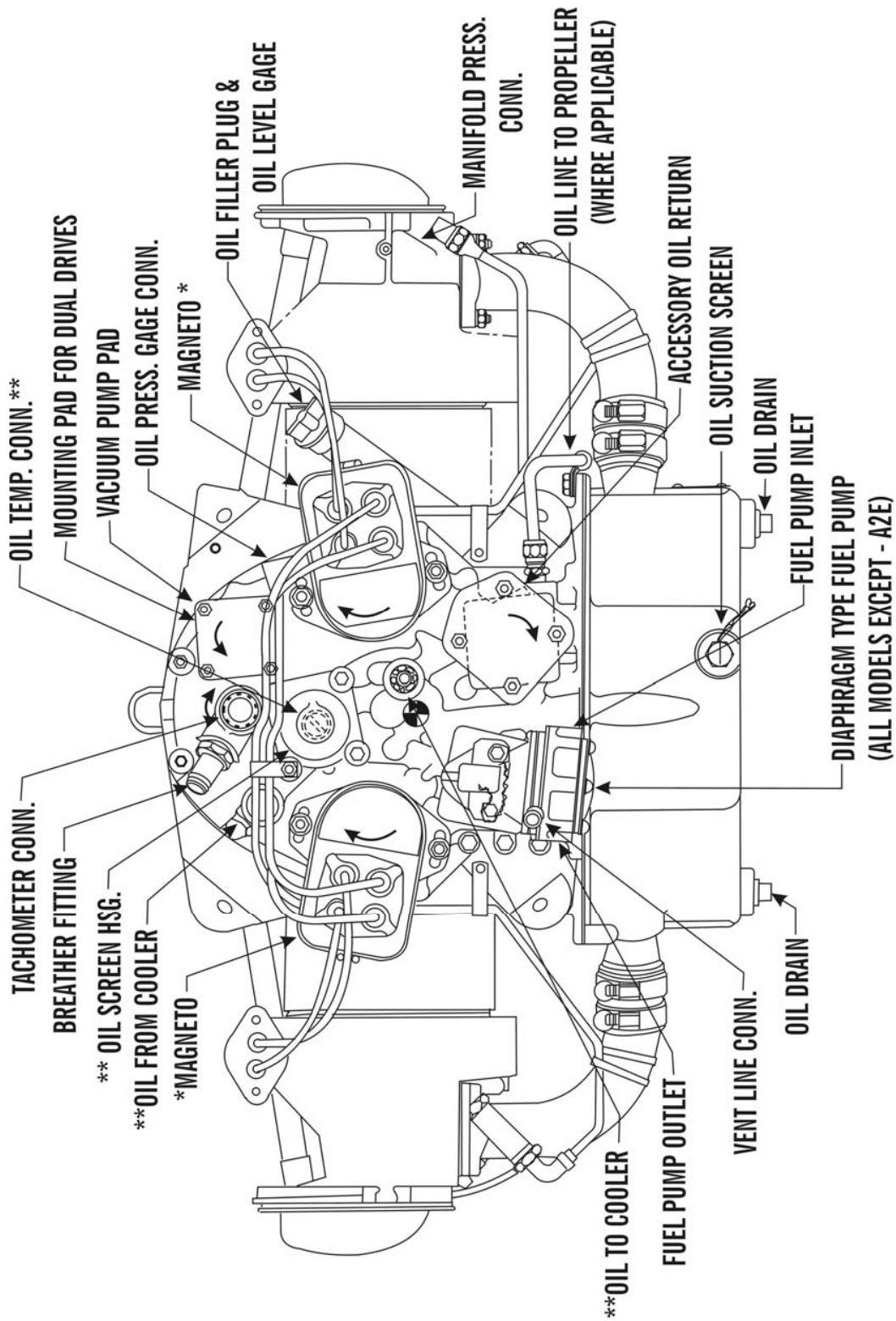
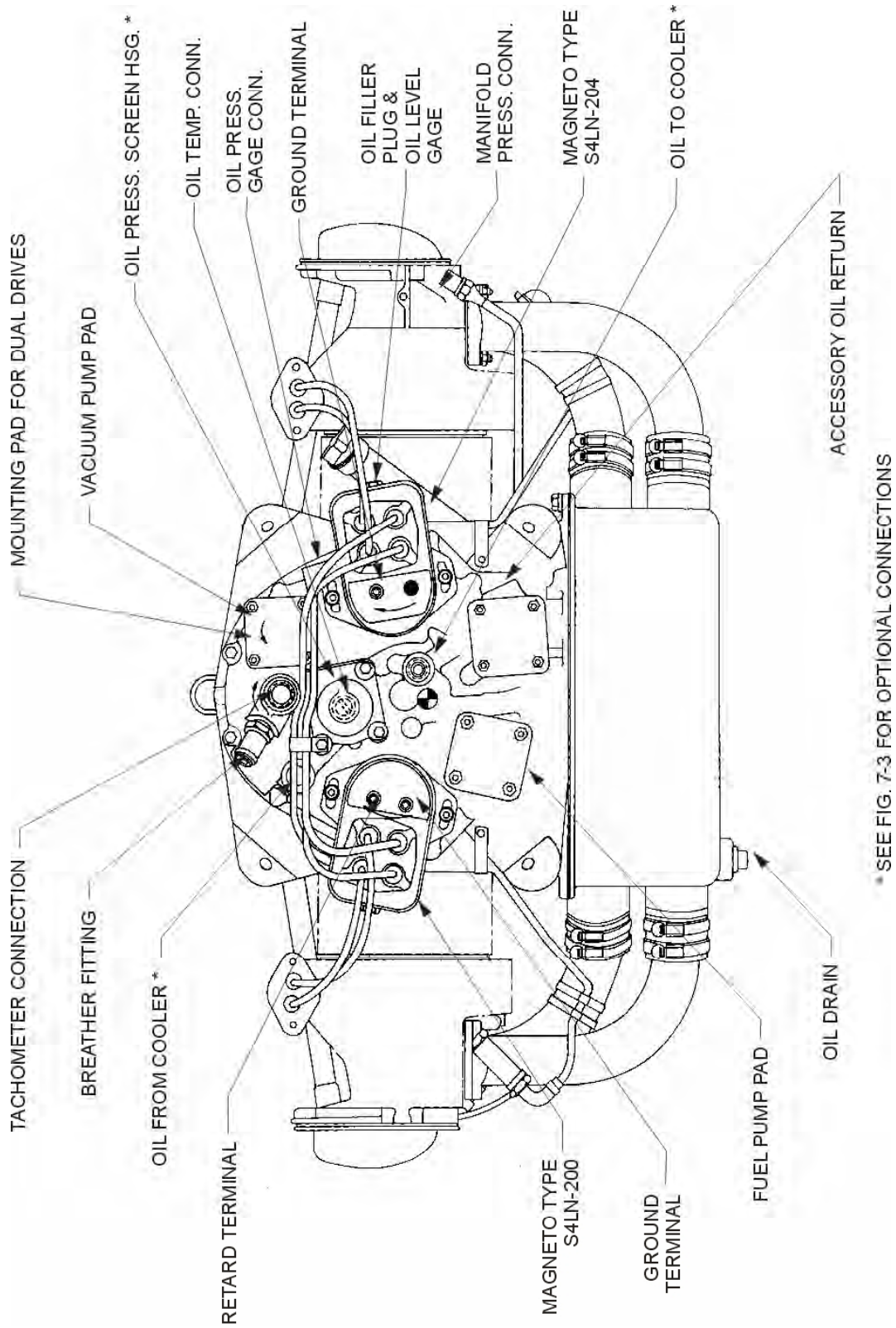

Figure 7-3. Optional Oil Cooler Connections



* SEE FIG. 7-2 FOR MAGNETO CONNECTIONS
 ** SEE FIG. 7-3 FOR OPTIONAL CONNECTIONS

Figure 7-4. Installation Drawing – O-360-A, -B Series (Except –A1C, -A1G)



* SEE FIG. 7-3 FOR OPTIONAL CONNECTIONS

Figure 7-5. Installation Drawing – O-360-A1C, IO-360-B1C

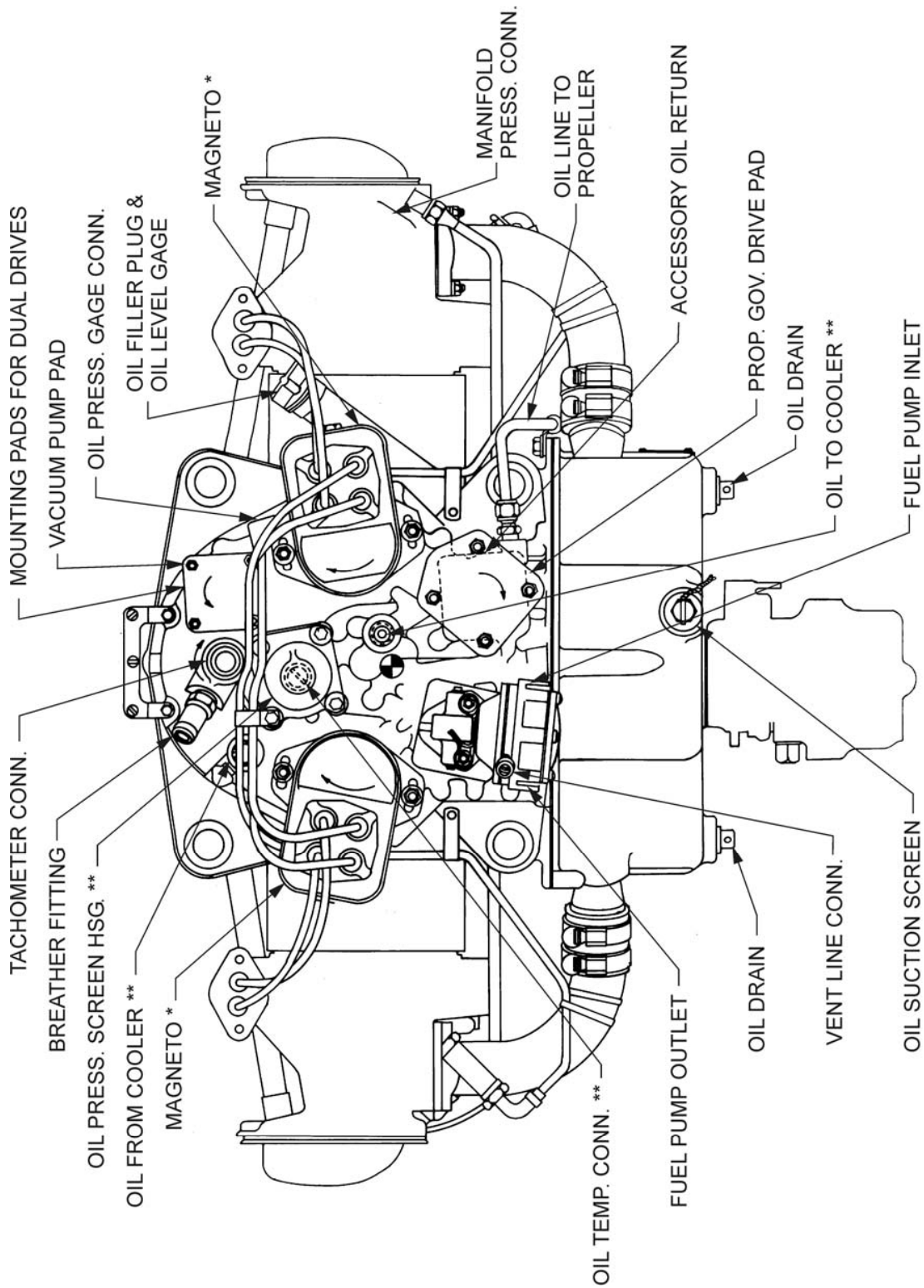

* SEE FIG. 7-2 FOR MAGNETO CONNECTIONS
** SEE FIG. 7-3 FOR OPTIONAL CONNECTIONS

Figure 7-6. Installation Drawing – O-360-C, -D Series (Except -C2B, -C2D)

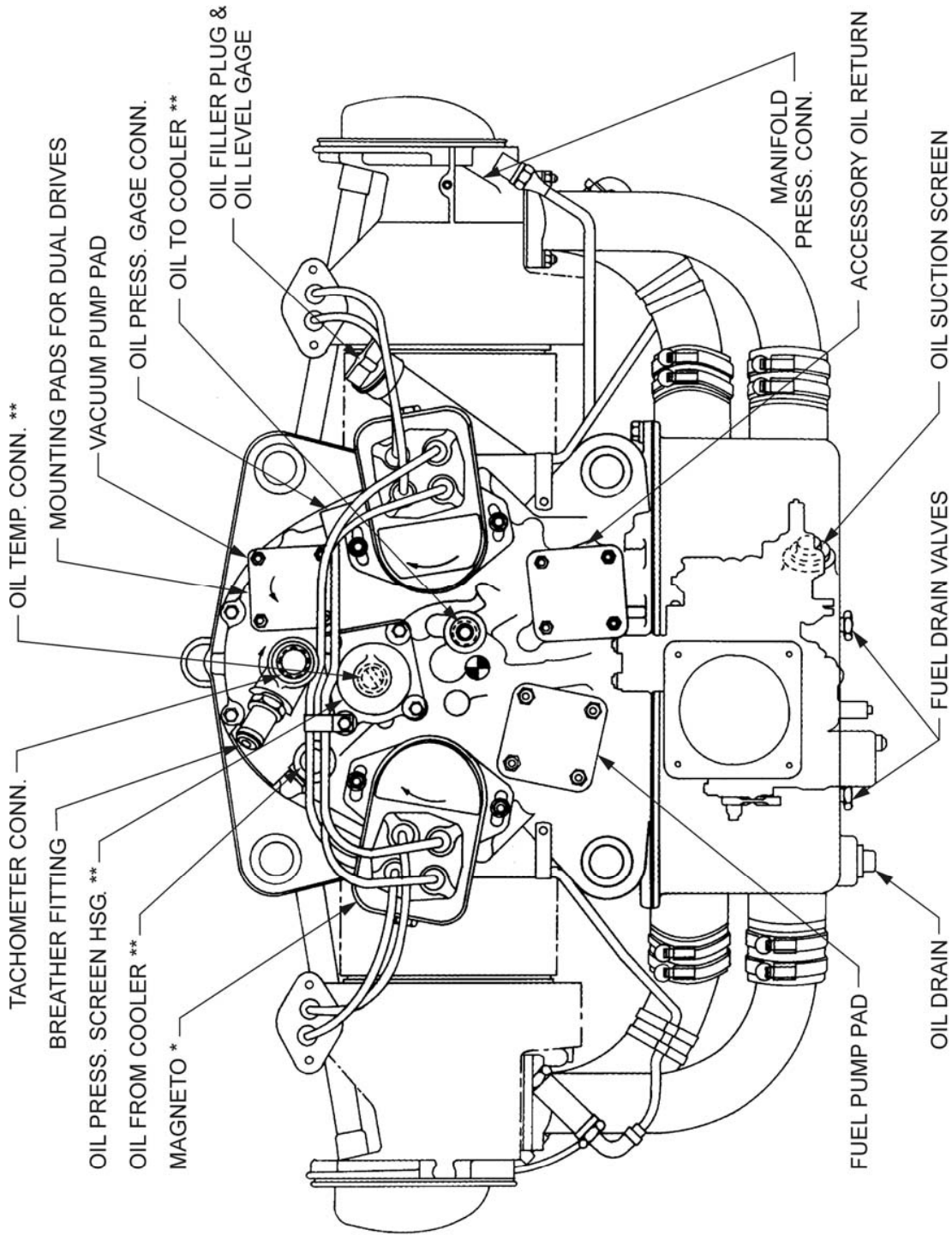

* SEE FIG. 7-2 FOR MAGNETO CONNECTIONS
 ** SEE FIG. 7-3 FOR OPTIONAL CONNECTIONS

Figure 7-7. Installation Drawing – O-360-C1B, -C1D; HO-360-B1A, -B1B

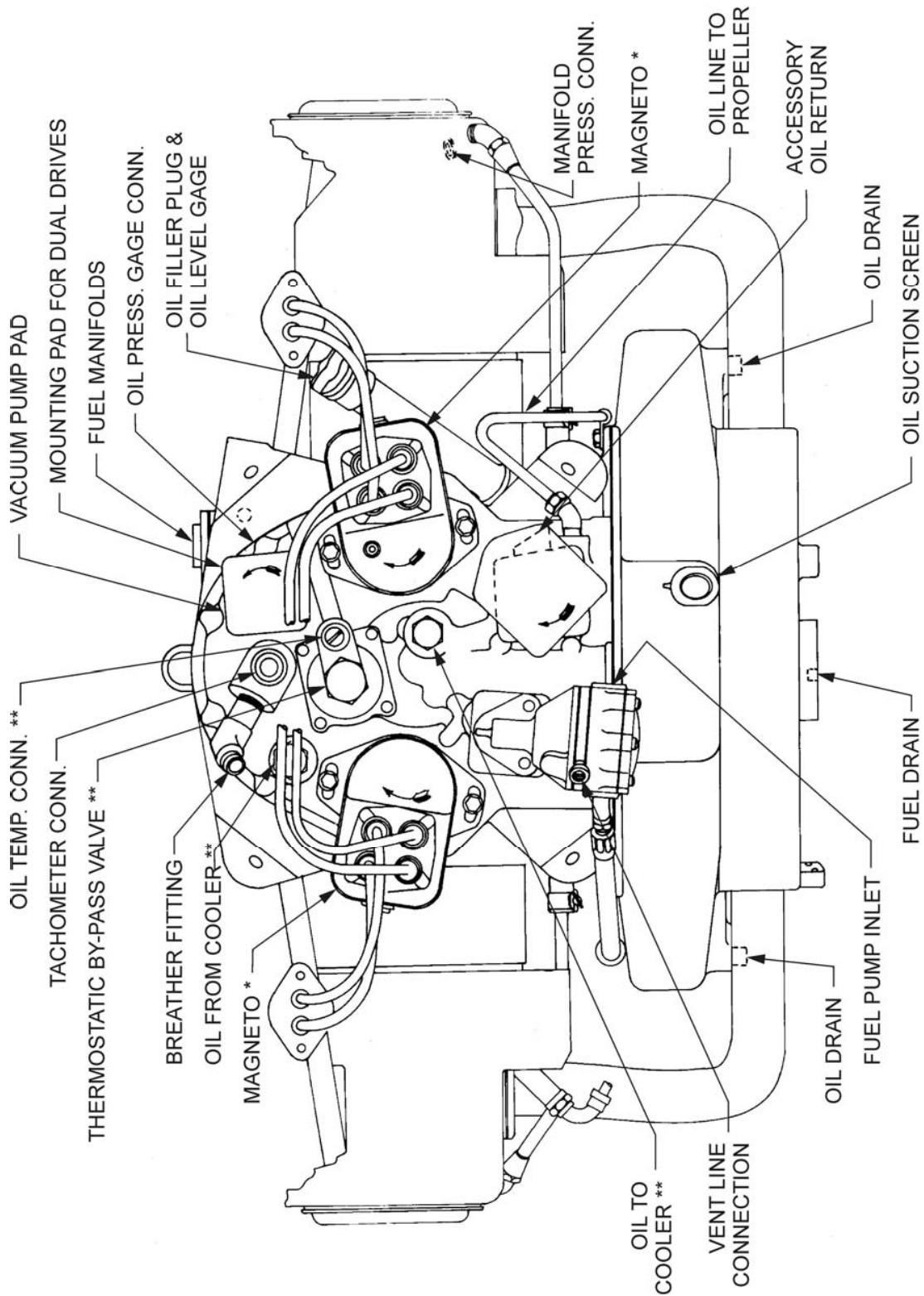

* SEE FIG. 7-2 FOR MAGNETO CONNECTIONS
** SEE FIG. 7-3 FOR OPTIONAL CONNECTIONS

Figure 7-8. Installation Drawing – IO-360-A Series

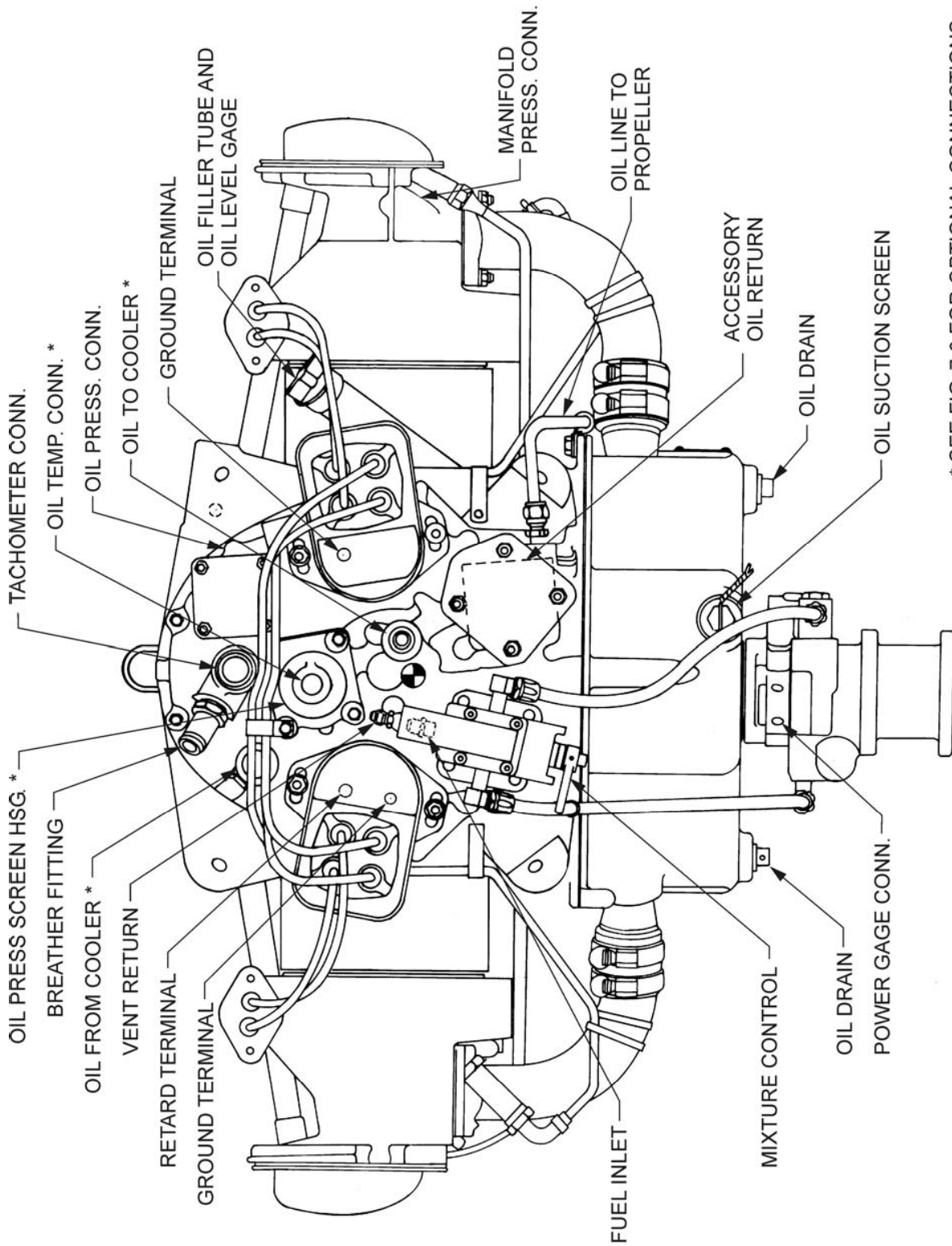

Figure 7-9. Installation Drawing – IO-360-B1A

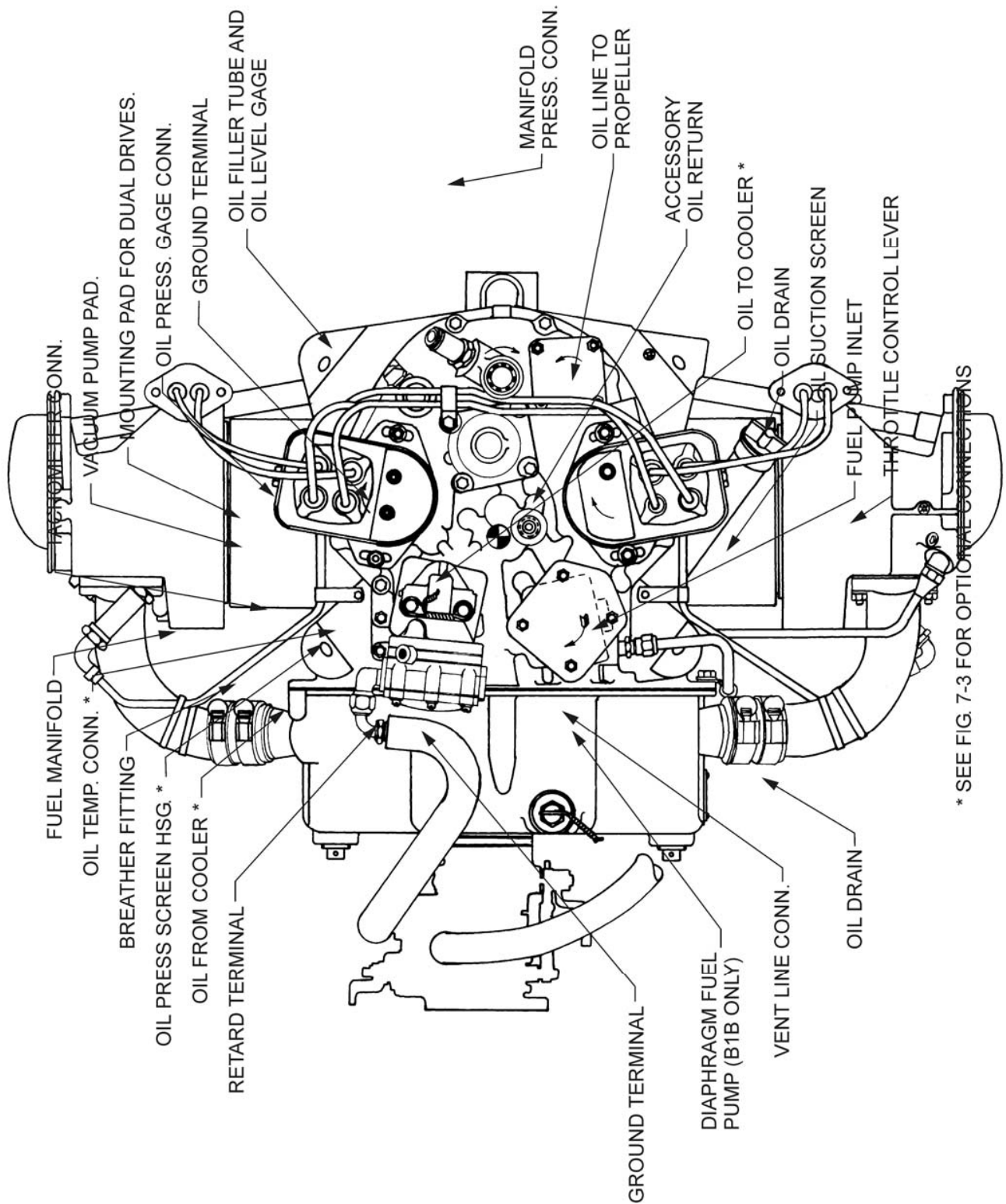
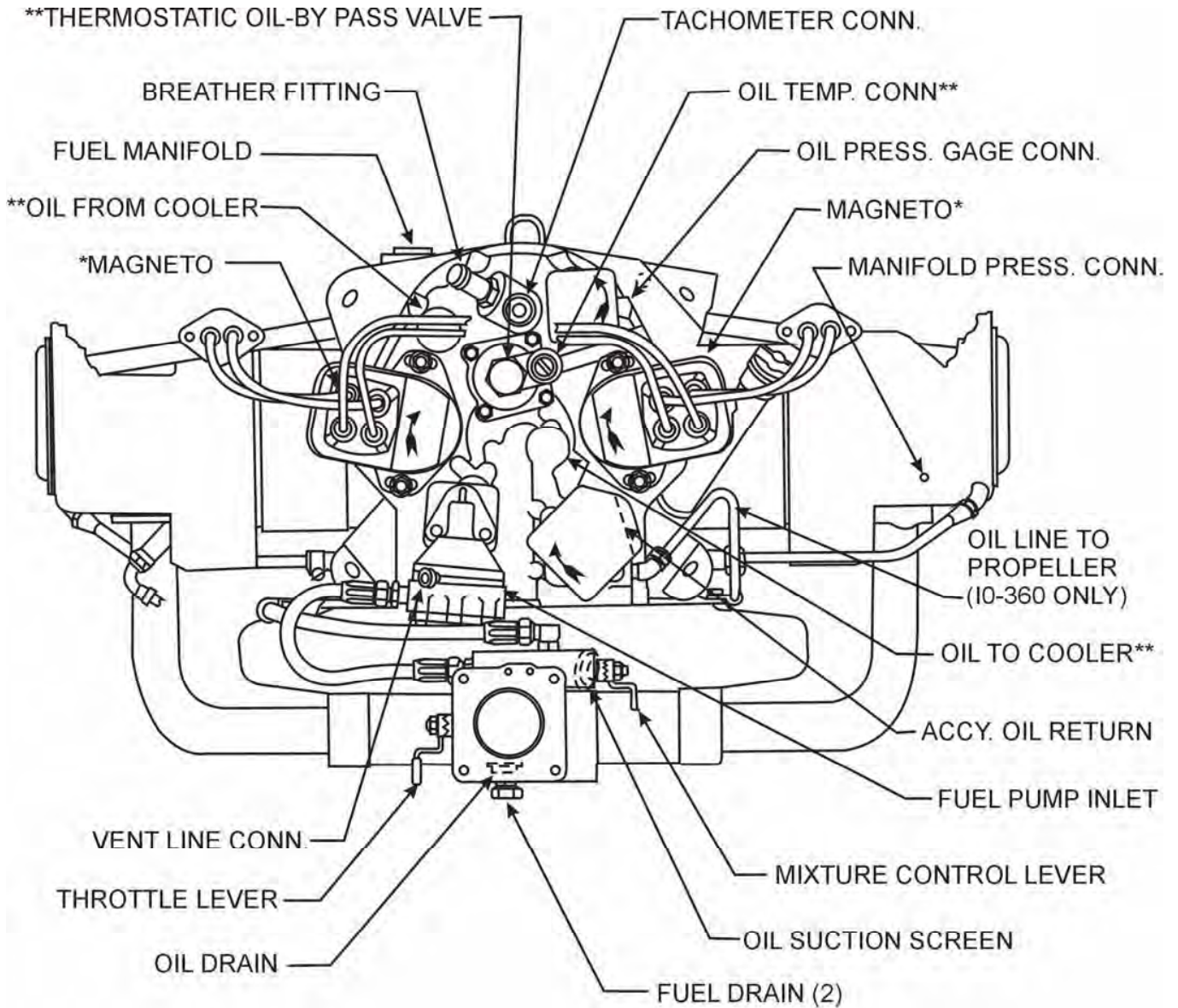
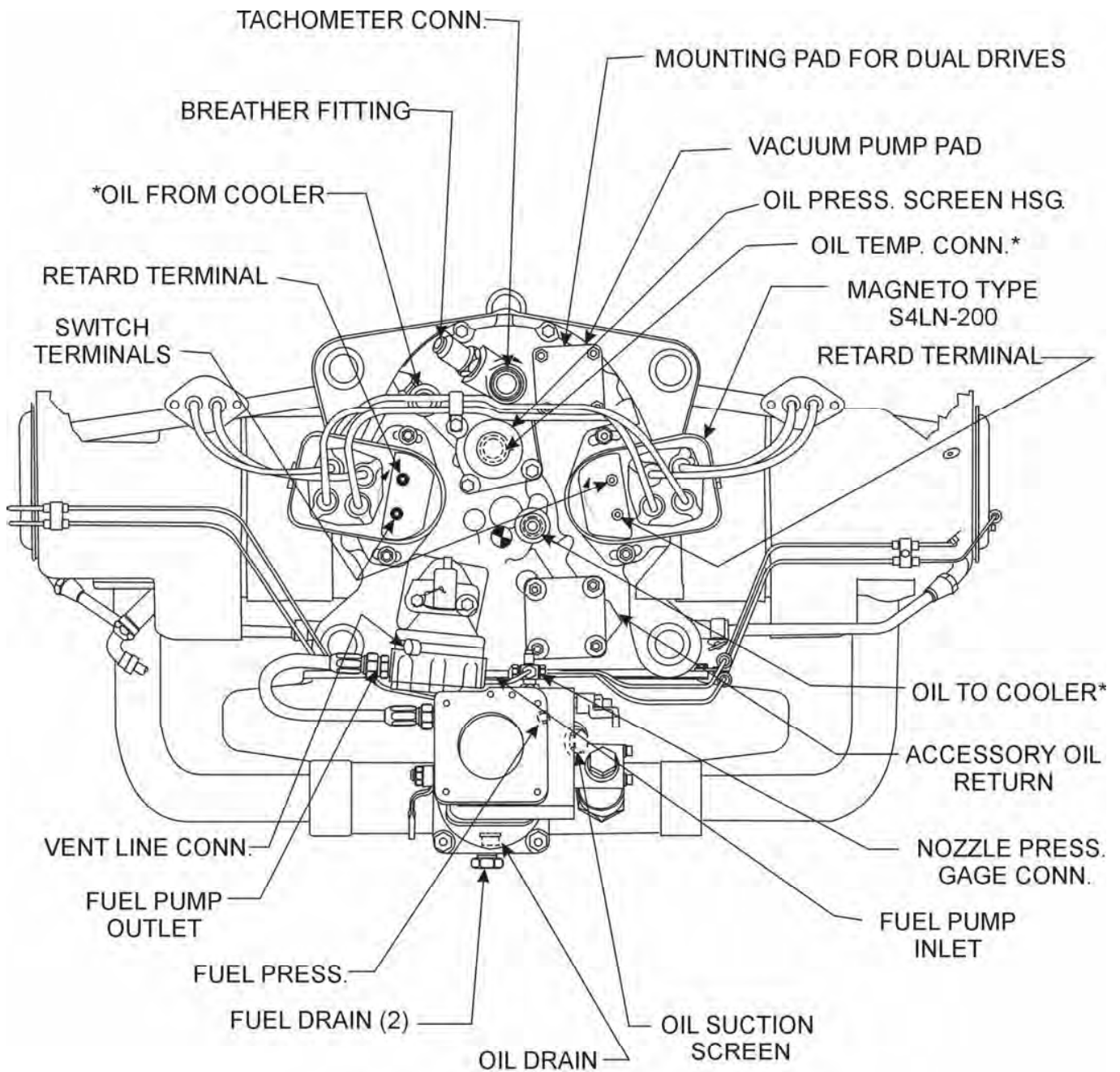

Figure 7-10. Installation Drawing – IO-360-B1B, -B1D



*SEE FIG 7-2 FOR MAGNETO CONNECTIONS
 **SEE FIG 7-3 FOR OPTIONAL CONNECTIONS

Figure 7-11. Installation Drawing – IO-360-C1A, -C1B, -D1A; HIO-360-C1A, -C1B



**SEE FIG. 7-3 FOR OPTIONAL CONNECTIONS*

Figure 7-12. Installation Drawing – HIO-360-A1A

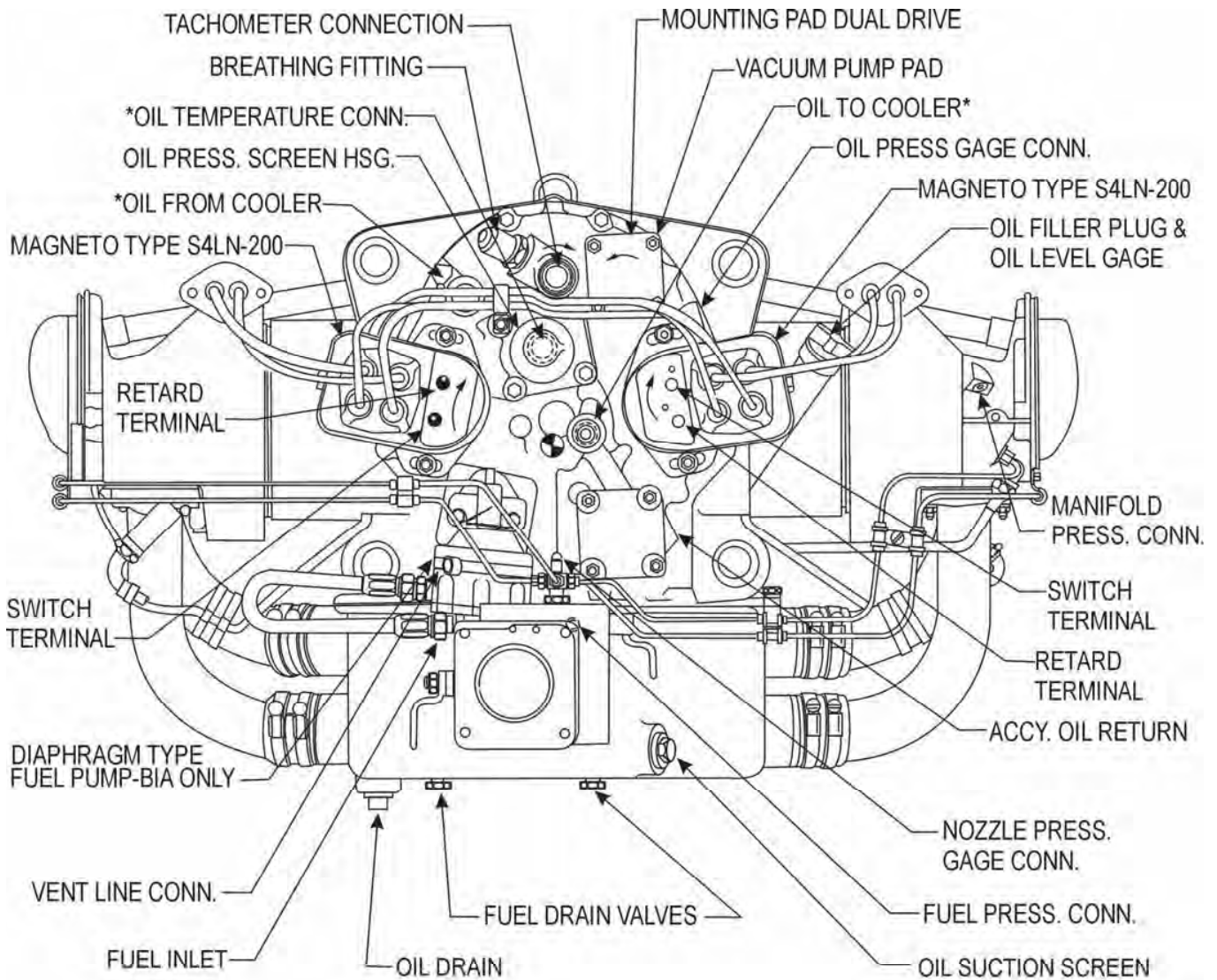

**SEE FIG 7-3 FOR OPTIONAL CONNECTIONS*

Figure 7-13. Installation Drawing – HIO-360-B1A, -B1B

LYCOMING OPERATOR'S MANUAL

SECTION 8 TABLES

	Page
Table of Limits	8-1
Ground Run After Top Overhaul	8-2
Flight Test After Top Overhaul.....	8-3
Full Throttle HP at Altitude.....	8-4
Table of Speed Equivalents	8-4
Centigrade – Fahrenheit Conversion Table	8-5
Inch Fraction Conversions	8-6

This Page Intentionally Left Blank

SECTION 8

TABLES

FOR TIGHTENING TORQUE RECOMMENDATIONS AND INFORMATION CONCERNING TOLERANCES AND DIMENSIONS THAT MUST BE MAINTAINED IN LYCOMING AIRCRAFT ENGINES, CONSULT THE LATEST EDITION OF SPECIAL SERVICE PUBLICATION NO. SSP-1776.

CONSULT LATEST REVISION OF SERVICE INSTRUCTION NO. 1029 FOR INFORMATION PERTINENT TO CORRECTLY INSTALLING CYLINDER ASSEMBLY.

FIXED WING ONLY

**GROUND RUN AFTER TOP OVERHAUL
OR CYLINDER CHANGE WITH NEW RINGS**

(DO NOT USE AFTER MAJOR OVERHAUL)

1. Avoid dusty location and loose stones.
2. Head aircraft into the wind.
3. All cowlings should be in place, cowl flaps open.
4. Accomplish ground run in full flat pitch.
5. Never exceed 200°F. oil temperature.
6. If cylinder head temperatures reach 400°F., shut down and allow engine to cool before continuing.

Type Aircraft _____
 Registration No. _____
 Aircraft No. _____
 Owner _____
 Engine Model _____ S/N _____
 Date _____
 Run-Up By _____

GROUND RUN

Time	RPM	MAP	Temperature				Pressure				Fuel Flow				
			L. oil	R. oil	L. cyl.	R. cyl.	L. oil	R. oil	L. fuel	R. fuel	L. carb.	R. carb.	Amb. Air	Left	Right
5 min	1000														
10 min	1200														
10 min	1300														
5 min	1500														
5 min	1600														
5 min	1700														
5 min	1800														

Mag. Check

Power Check

Idle Check

Adjustment Required

After Completion of Ground Run

1. Visually inspect engine(s)
2. Check oil levels

**FLIGHT TEST AFTER TOP OVERHAUL
OR CYLINDER CHANGE WITH NEW RINGS**

1. Test fly aircraft one hour.
2. Use standard power for climb, and at least 75% power for cruise.
3. Make climb shallow and at good airspeed for cooling.
4. Record engine instrument readings during climb and cruise.

Tested by _____

FLIGHT TEST RECORD

Time (Climb) Cruise	RPM	MAP	Temperature			Pressure			Temperature			Fuel Flow												
			L. oil	R. oil	L. cyl.	R. cyl.	L. oil	R. oil	L. fuel	R. fuel	L. carb	R. carb	Amb. Air	Left	Right									

Adjustment Required After Flight

After Test Flight.

1. Make careful visual inspection of engine(s).
2. Check oil level(s).
3. If oil consumption is excessive, (see operator's manual for limits), remove spark plugs and check cylinder barrels for scoring.

**SECTION 8
TABLES**

**LYCOMING OPERATOR'S MANUAL
O-360 AND ASSOCIATED MODELS**

**FULL THROTTLE HP AT ALTITUDE
(Normally Aspirated Engines)**

Altitude Ft.	% S.L. H.P.	Altitude Ft.	% S.L. H.P.	Altitude Ft.	% S.L. H.P.
0	100	10,000	70.8	19,500	49.1
500	98.5	11,000	68.3	20,000	48.0
1,000	96.8	12,000	65.8	20,500	47.6
2,000	93.6	13,000	63.4	21,000	46.0
2,500	92.0	14,000	61.0	21,500	45.2
3,000	90.5	15,000	58.7	22,000	44.0
4,000	87.5	16,000	56.5	22,500	43.3
5,000	84.6	17,000	54.3	23,000	42.2
6,000	81.7	17,500	53.1	23,500	41.4
7,000	78.9	18,000	52.1	24,000	40.3
8,000	76.2	18,500	51.4	24,500	39.5
9,000	73.5	19,000	50.0	25,000	38.5

TABLE OF SPEED EQUIVALENTS

Sec./Mi.	M.P.H.	Sec./Mi.	M.P.H.	Sec./Mi.	M.P.H.
72.0	50	24.0	150	14.4	250
60.0	60	22.5	160	13.8	260
51.4	70	21.2	170	13.3	270
45.0	80	20.0	180	12.8	280
40.0	90	18.9	190	12.4	290
36.0	100	18.0	200	12.0	300
32.7	110	17.1	210	11.6	310
30.0	120	16.4	220	11.2	320
27.7	130	15.6	230	10.9	330
25.7	140	15.0	240	10.6	340

CENTIGRADE – FAHRENHEIT CONVERSION TABLE

Example: To convert 20°C to Fahrenheit, find 20 in the center column headed (F-C); then read 68.0°F in the column (F) to the right. To convert 20°F to Centigrade; find 20 in the center column and read -6.67°C in the (C) column to the left.

C	F-C	F	C	F-C	F
-56.7	-70	-94.0	104.44	220	428.0
-51.1	-60	-76.0	110.00	230	446.0
-45.6	-50	-58.0	115.56	240	464.4
-40.0	-40	-40.0	121.11	250	482.0
-34.0	-30	-22.0	126.67	260	500.0
-28.9	-20	-4.0	132.22	270	518.0
-23.3	-10	14.0	137.78	280	536.0
-17.8	0	32.0	143.33	290	554.0
-12.22	10	50.0	148.89	300	572.0
-6.67	20	68.0	154.44	310	590.0
-1.11	30	86.0	160.00	320	608.0
4.44	40	104.0	165.56	330	626.0
10.00	50	122.0	171.11	340	644.0
15.56	60	140.0	176.67	350	662.0
21.11	70	158.0	182.22	360	680.0
26.67	80	176.0	187.78	370	698.0
32.22	90	194.0	193.33	380	716.0
37.78	100	212.0	198.89	390	734.0
43.33	110	230.0	204.44	400	752.0
48.89	120	248.0	210.00	410	770.0
54.44	130	266.0	215.56	420	788.0
60.00	140	284.0	221.11	430	806.0
65.56	150	302.0	226.67	440	824.0
71.00	160	320.0	232.22	450	842.0
76.67	170	338.0	237.78	460	860.0
82.22	180	356.0	243.33	470	878.0
87.78	190	374.0	248.89	480	896.0
93.33	200	392.0	254.44	490	914.0
98.89	210	410.0	260.00	500	932.0

**SECTION 8
TABLES**

**LYCOMING OPERATOR'S MANUAL
O-360 AND ASSOCIATED MODELS**

INCH FRACTIONS CONVERSIONS
Decimals, Area of Circles and Millimeters

Inch Fraction	Decimal Equiv.	Area Sq. In.	MM Equiv.	Inch Fraction	Decimal Equiv.	Area Sq. In.	MM Equiv.
1/64	.0156	.0002	.397	1/2	.5	.1964	12.700
1/32	.0312	.0008	.794	17/32	.5312	.2217	13.494
3/64	.0469	.0017	1.191	35/64	.5469	.2349	13.891
1/16	.0625	.0031	1.587	9/16	.5625	.2485	14.288
3/32	.0937	.0069	2.381	19/32	.5937	.2769	15.081
7/64	.1094	.0094	2.778	39/64	.6094	.2916	15.478
1/8	.125	.0123	3.175	5/8	.625	.3068	15.875
5/32	.1562	.0192	3.969	21/32	.6562	.3382	16.669
11/64	.1719	.0232	4.366	43/64	.6719	.3545	17.065
3/16	.1875	.0276	4.762	11/16	.6875	.3712	17.462
7/32	.2187	.0376	5.556	23/32	.7187	.4057	18.256
15/64	.2344	.0431	5.593	47/64	.7344	.4235	18.653
1/4	.25	.0491	6.350	3/4	.75	.4418	19.050
9/32	.2812	.0621	7.144	25/32	.7812	.4794	19.844
19/64	.2969	.0692	7.540	51/64	.7969	.4987	20.241
5/16	.3125	.0767	7.937	13/16	.8125	.5185	20.637
11/32	.3437	.0928	8.731	27/32	.8437	.5591	21.431
23/64	.3594	.1014	9.128	55/64	.8594	.5800	21.828
3/8	.375	.1105	9.525	7/8	.875	.6013	22.225
13/32	.4062	.1296	10.319	29/32	.9062	.6450	23.019
27/64	.4219	.1398	10.716	59/64	.9219	.6675	23.416
7/16	.4375	.1503	11.112	15/16	.9375	.6903	23.812
15/32	.4687	.1725	11.906	31/32	.9687	.7371	24.606
31/64	.4844	.1842	12.303	63/64	.9844	.7610	25.003